

**All ADATs are drawn with a QE (Angle of departure) of <150 mils and a 20 mils Coff**

**NZ Police Ammunition Danger Area Templates (ADAT) – 1:25000 Scale – T1 to T4**

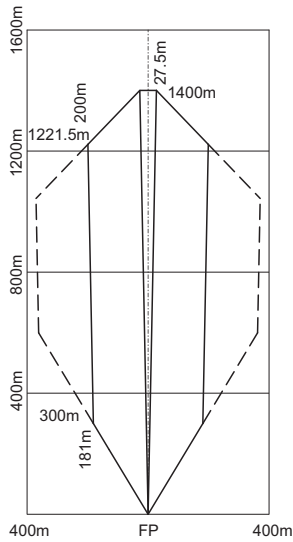

**T1 - RIMFIRE RIFLE & PISTOLS**

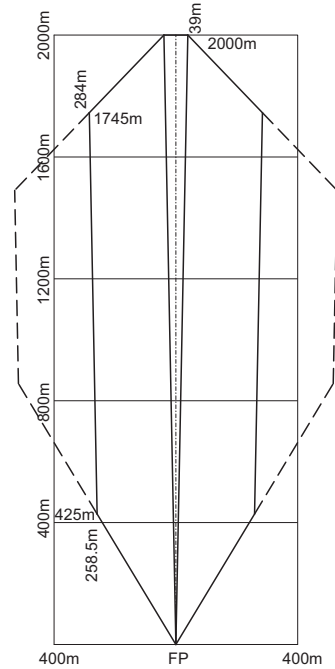

**T2 - CENTREFIRE PISTOLS UP TO .50CAL**

**TEST BOX:**

This is a 4 cm x 4 cm square box drawn to scale, to test the accuracy of your printed version. Measure the test box to confirm you have printed these drawings to the correct size. Your printer setting should be set at 'Scale 100%' or 'A4'.  
**Do not use if not to scale.**

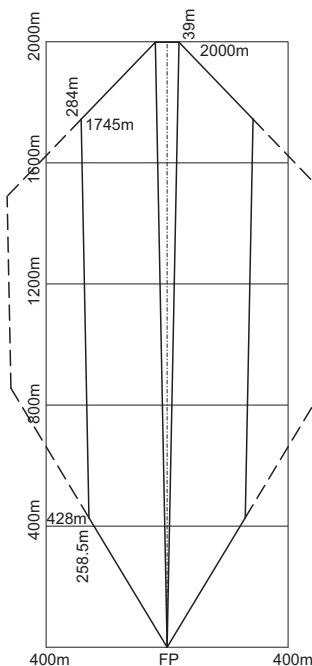

**T3 - MUZZLE LOADING AND PERCUSSION RIFLES**

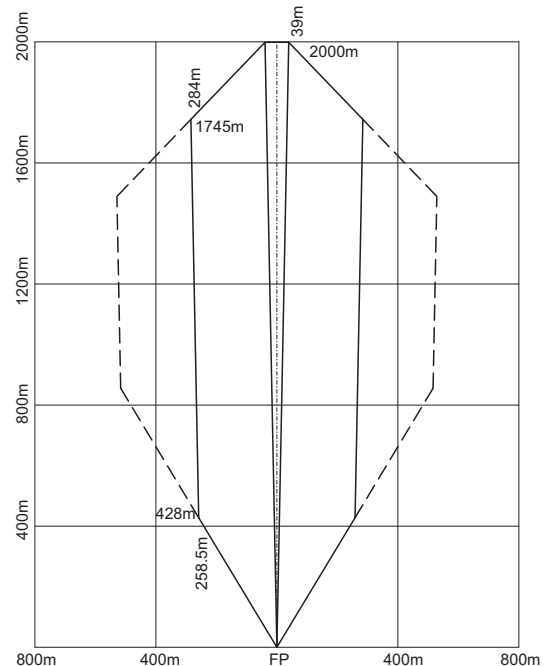

**T4 - CENTREFIRE RIFLES UP TO .223 INCH/5.56MM**

**NZ Police Ammunition Danger Area Templates (ADAT) – 1:25000 Scale – T5 to T6**

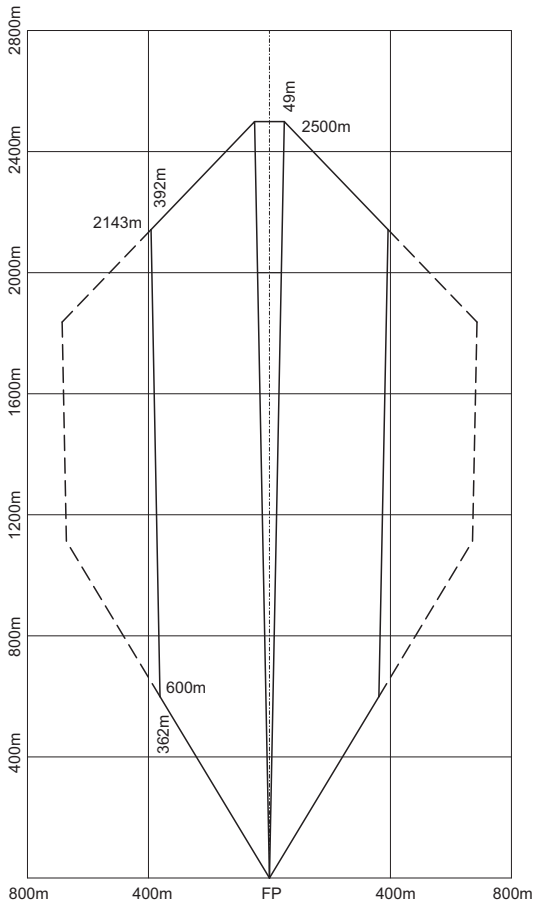

**T5 - CENTREFIRE RIFLES UP TO .223 INCH/5.56MM**

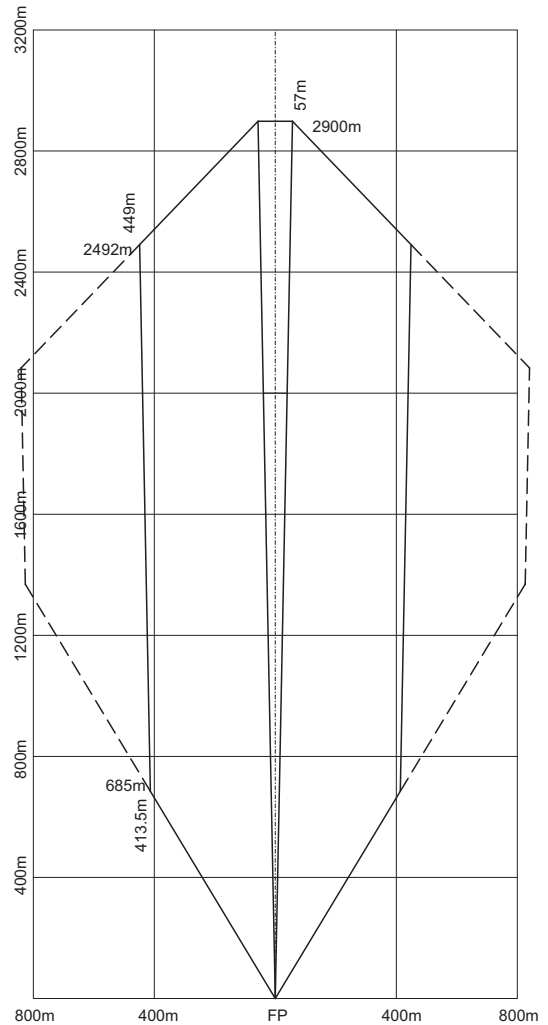

**T6 - CENTREFIRE RIFLES .308 INCH/7.62MM UP TO 8MM**

**TEST BOX:**  
This is a 4 cm x 4 cm square box drawn to scale, to test the accuracy of your printed version. Measure the test box to confirm you have printed these drawings to the correct size. Your printer setting should be set at 'Scale 100%' or 'A4'.  
**Do not use if not to scale.**

**NZ Police Ammunition Danger Area Templates (ADAT) – 1:25000 Scale – T7**

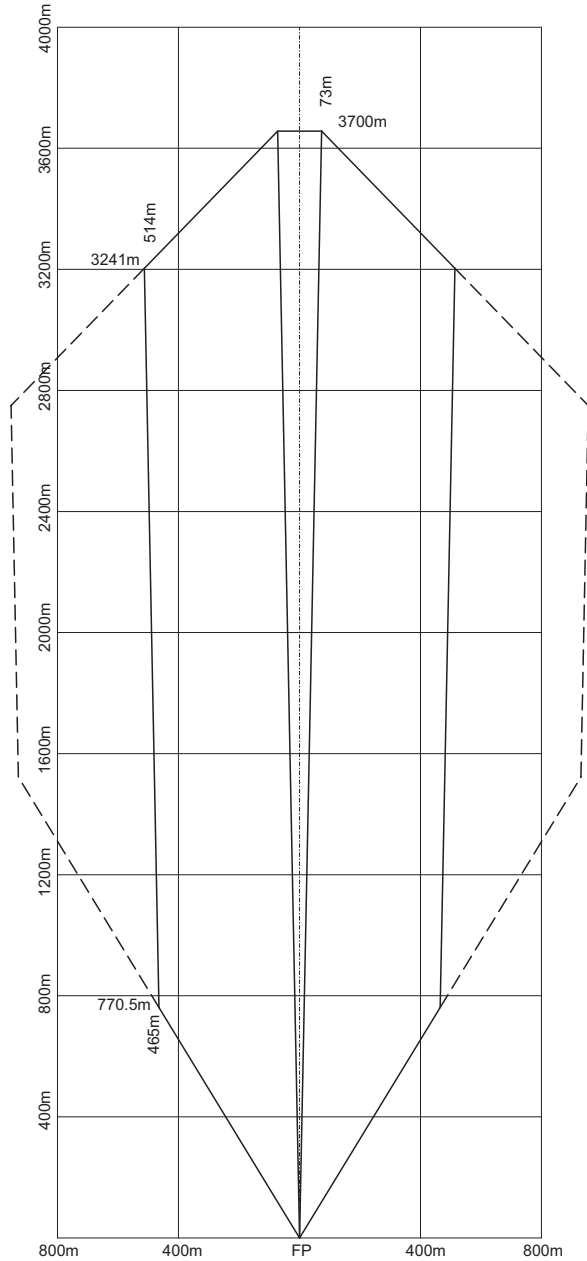

**T7 - CENTREFIRE RIFLE .338 INCH**

**TEST BOX:**  
This is a 4 cm x 4 cm square box drawn to scale, to test the accuracy of your printed version. Measure the test box to confirm you have printed these drawings to the correct size. Your printer setting should be set at 'Scale 100%' or 'A4'.  
**Do not use if not to scale.**

**NZ Police Ammunition  
Danger Area Templates  
(ADAT)  
1:25000 Scale – T8**

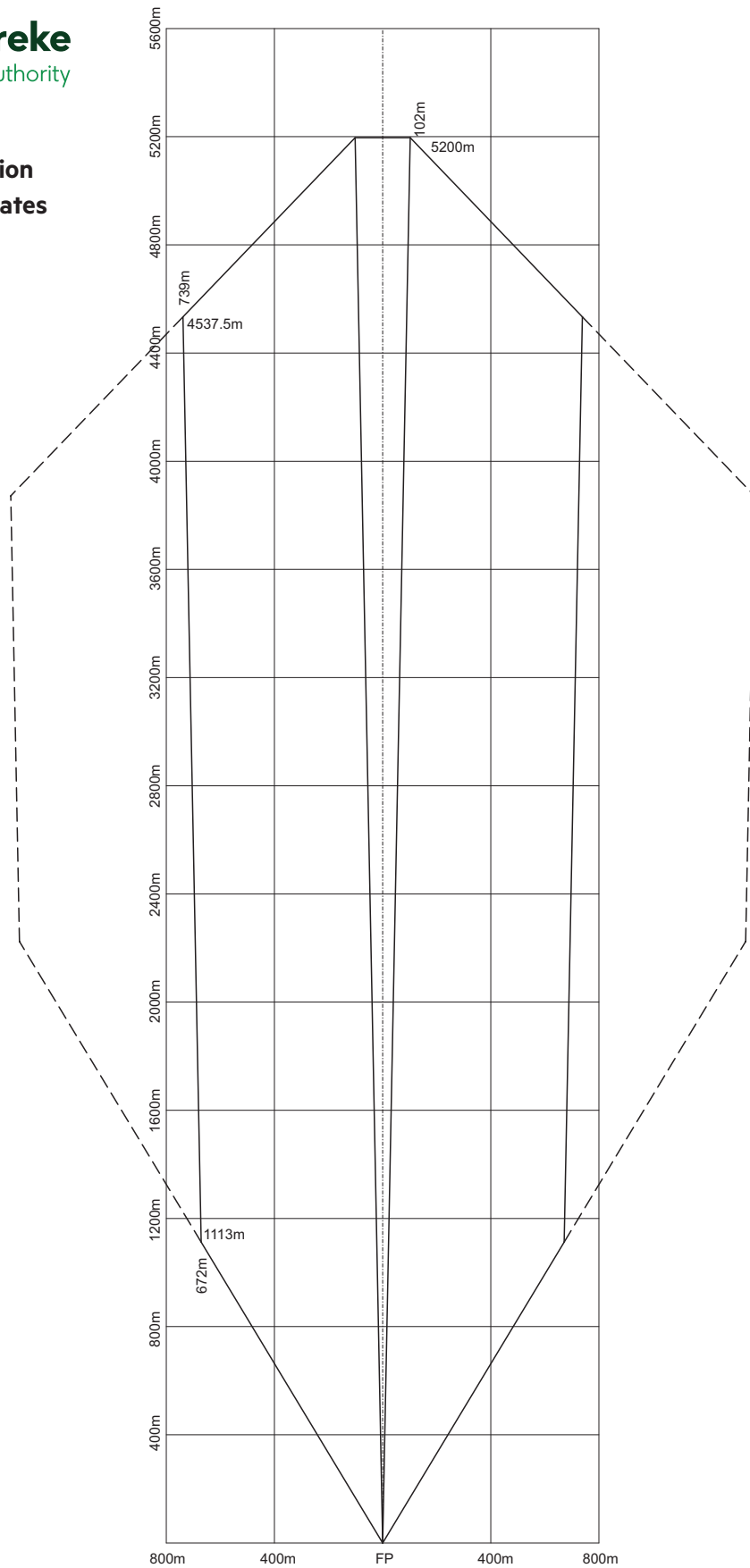

**T8 - CENTREFIRE RIFLE .50 INCH**

**TEST BOX:**  
This is a 4 cm x 4 cm square box drawn to scale, to test the accuracy of your printed version. Measure the test box to confirm you have printed these drawings to the correct size. Your printer setting should be set at 'Scale 100%' or 'A4'.  
**Do not use if not to scale.**

**NZ Police Ammunition Danger Area Templates (ADAT) – 1:50000 Scale – T1 to T4**

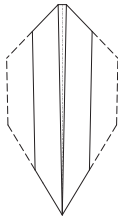

**T1 - RIMFIRE RIFLE & PISTOLS**

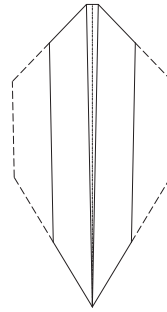

**T2 - CENTREFIRE PISTOLS UP TO .50CAL**



This is a 2 cm x 2 cm square box drawn to scale, to test the accuracy of your printed version. Measure the test box to confirm you have printed these drawings to the correct size. Your printer setting should be set at 'Scale 100%' or 'A4'.  
**Do not use if not to scale.**

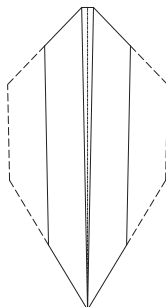

**T3 - MUZZLELOADING AND PERCUSSION RIFLES**

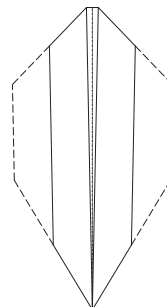

**T4 - CENTREFIRE RIFLES UP TO .223 INCH/5.56MM**

**NZ Police Ammunition Danger Area Templates (ADAT) – 1:50000 Scale – T5 to T8**

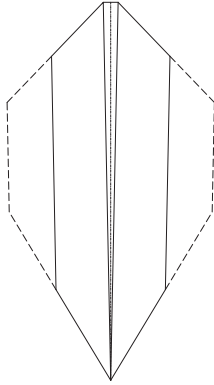

**T5 - CENTREFIRE RIFLES UP TO .223 INCH/5.56MM**

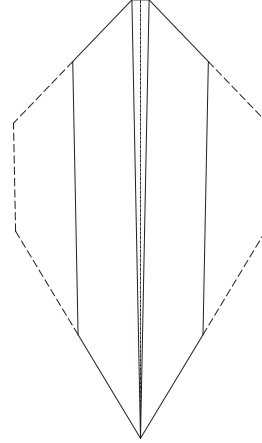

**T6 - CENTREFIRE RIFLES .308 INCH/7.62MM UP TO 8MM**



This is a 2 cm x 2 cm square box drawn to scale, to test the accuracy of your printed version. Measure the test box to confirm you have printed these drawings to the correct size. Your printer setting should be set at 'Scale 100%' or 'A4'.  
**Do not use if not to scale.**

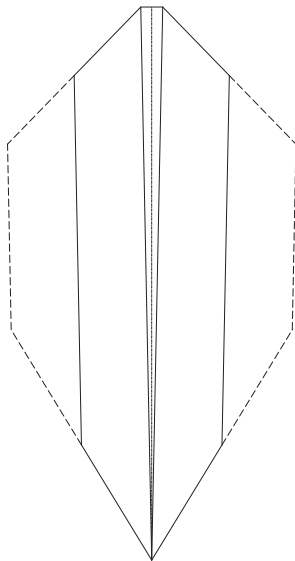

**T7 - CENTREFIRE RIFLE .338 INCH**

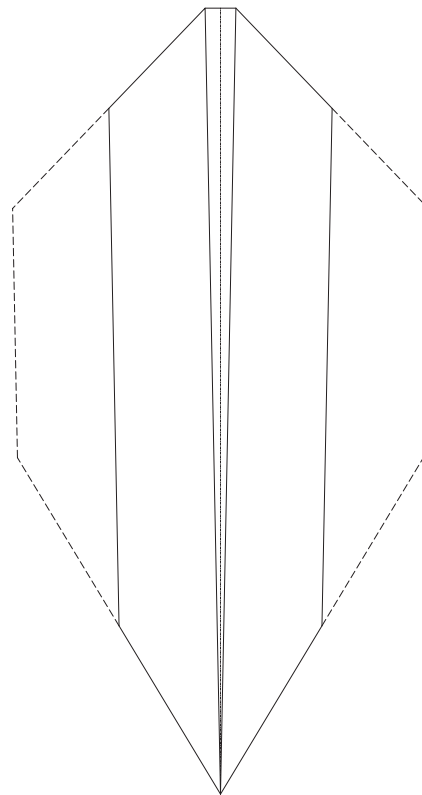

**T8 - CENTREFIRE RIFLE .50 INCH**