

All ADATs are drawn with a Quadrant Elevation of 150 mils

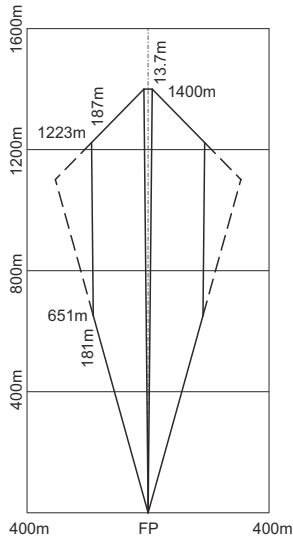

T1 - 22 LR RIMFIRE RIFLE

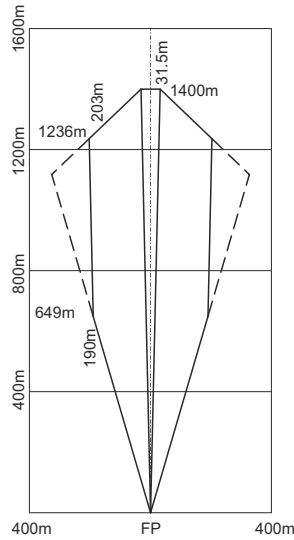

T1a - RIMFIRE PISTOLS

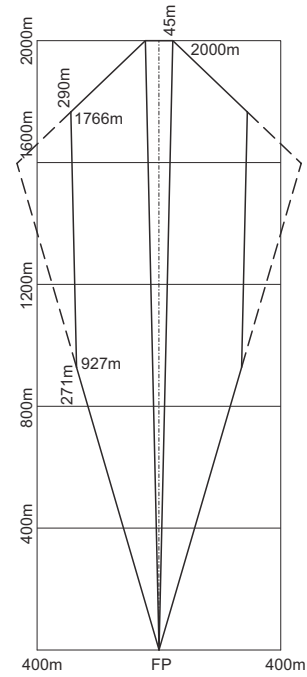

T2 - CENTREFIRE PISTOLS UP TO .50CAL

TEST BOX:
This is a 4 cm x 4 cm square box drawn to scale, to test the accuracy of your printed version. Measure the test box to confirm you have printed these drawings to the correct size. Your printer setting should be set at 'Scale 100%' or 'A4'.
Do not use if not to scale.

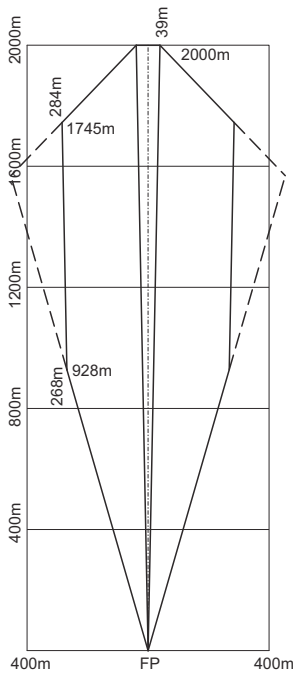

T3 - MUZZLELOADING AND PERCUSSION RIFLES

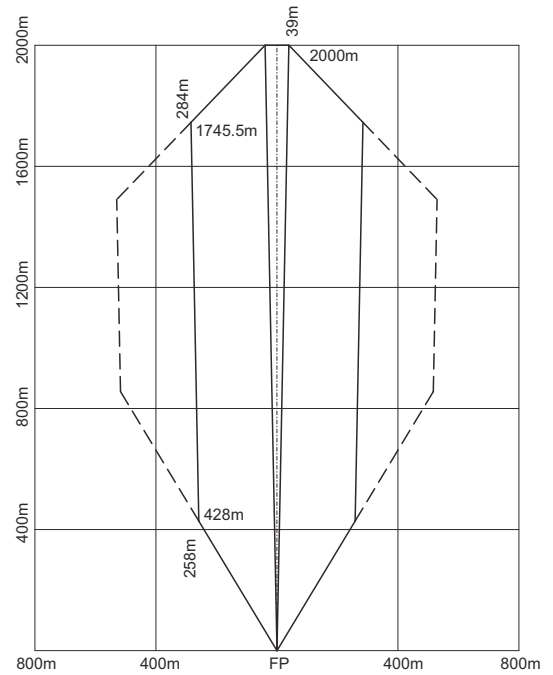

T4 - CENTREFIRE RIFLES UP TO .223 INCH/5.56MM

NZ Police Ammunition Danger Area Templates (ADAT) – 1:25000 Scale – T1 to T4

NZ Police Ammunition Danger Area Templates (ADAT) – 1:25000 Scale – T5 to T6

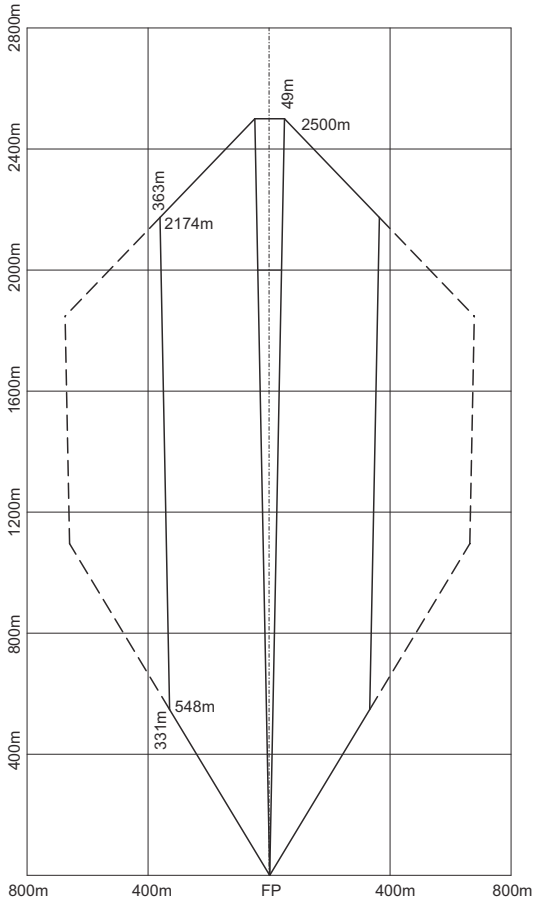

T5 - CENTREFIRE RIFLES UP TO .223 INCH/5.56MM

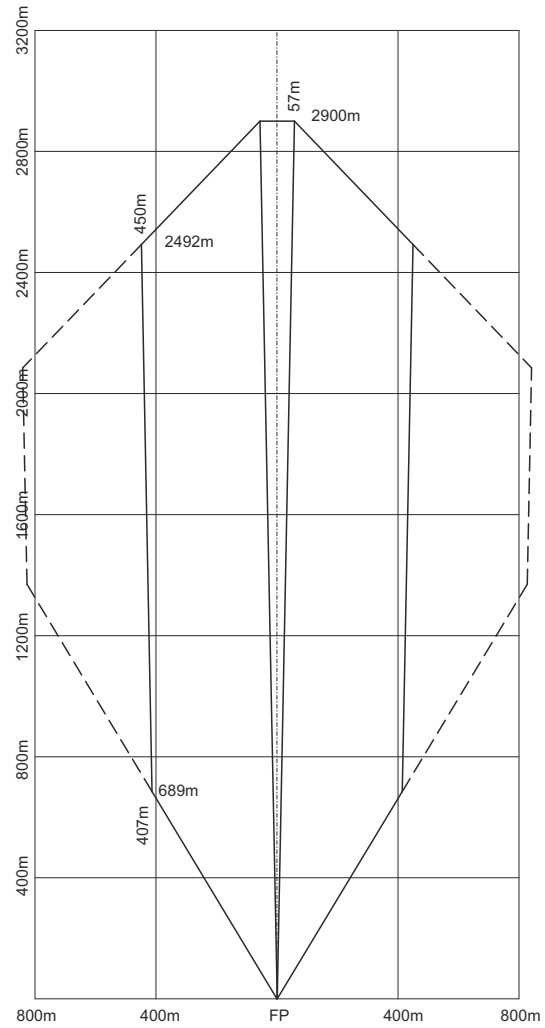

T6 - CENTREFIRE RIFLES .308 INCH/7.62MM UP TO 8MM

TEST BOX:

This is a 4 cm x 4 cm square box drawn to scale, to test the accuracy of your printed version. Measure the test box to confirm you have printed these drawings to the correct size. Your printer setting should be set at 'Scale 100%' or 'A4'.

Do not use if not to scale.

NZ Police Ammunition Danger Area Templates (ADAT) – 1:25000 Scale – T7

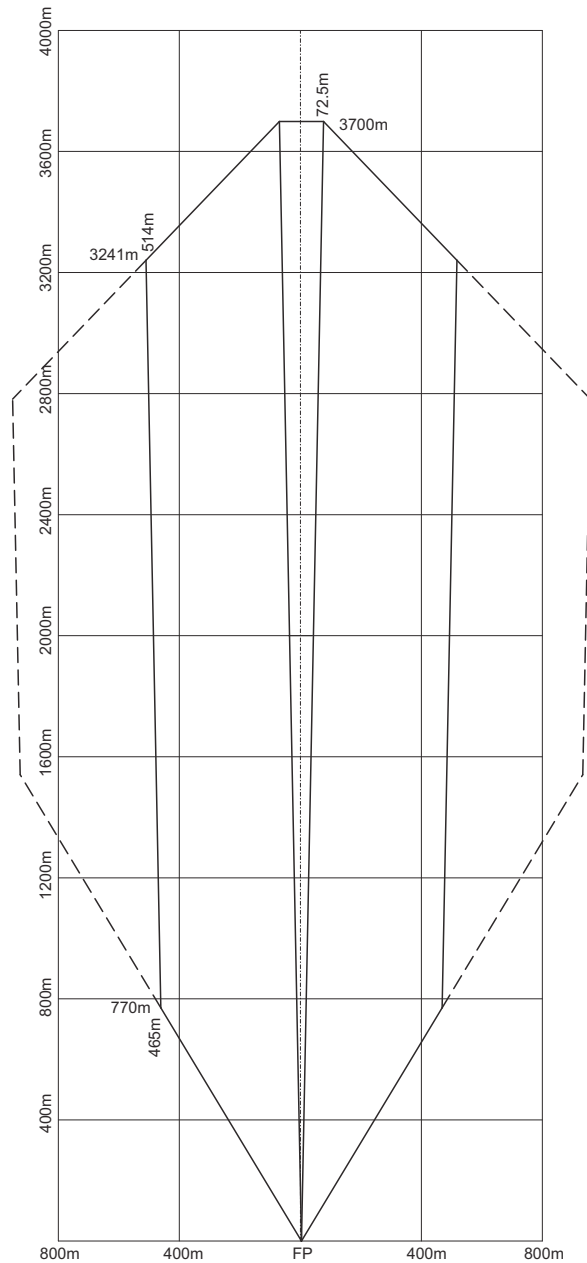

T7 - CENTREFIRE RIFLE .338 INCH

TEST BOX:
This is a 4 cm x 4 cm square box drawn to scale, to test the accuracy of your printed version. Measure the test box to confirm you have printed these drawings to the correct size. Your printer setting should be set at "Scale 100%" or "A4".
Do not use if not to scale.



**NZ Police Ammunition
Danger Area Templates
(ADAT)
1:25000 Scale – T8**

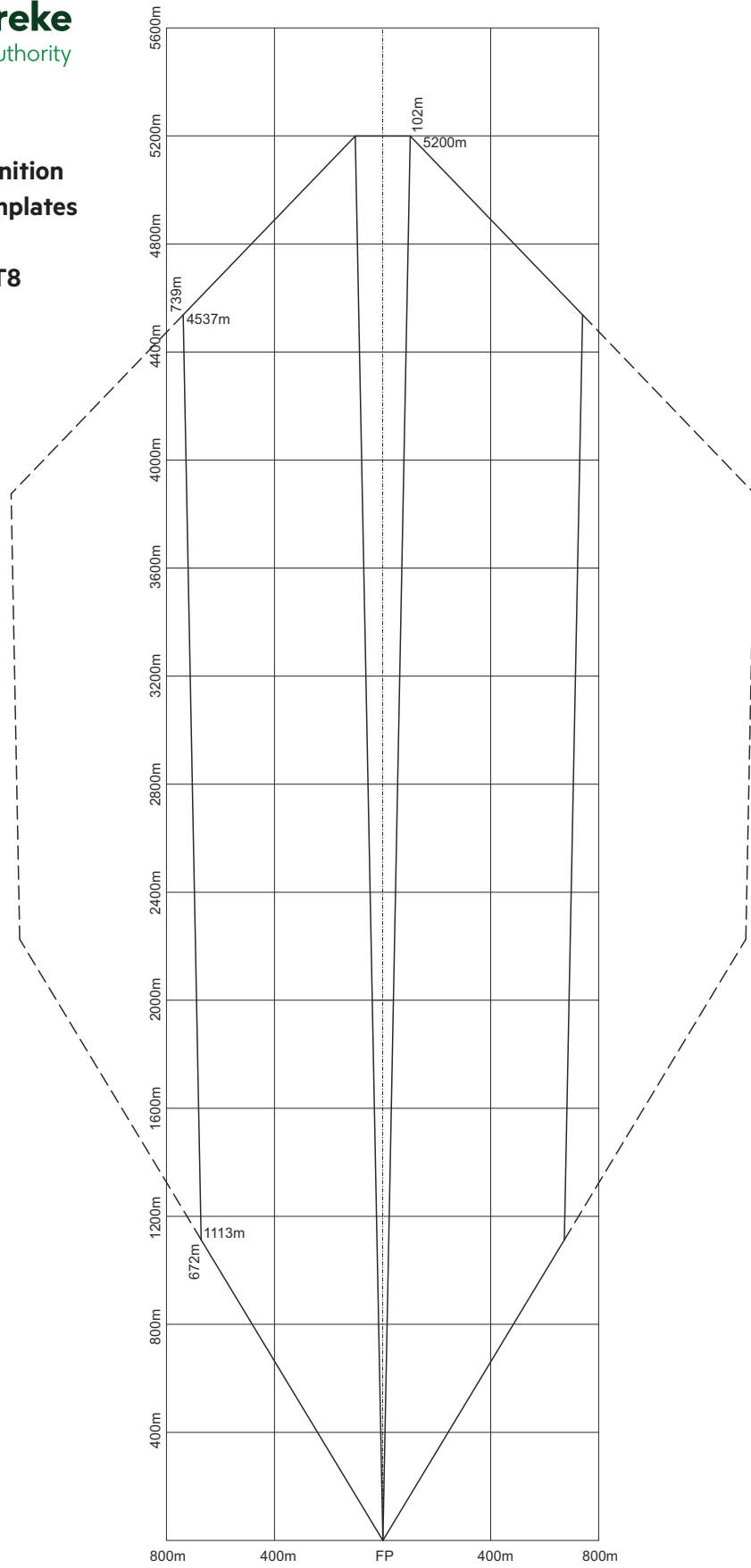

T8 - CENTREFIRE RIFLE .50 INCH

TEST BOX:
This is a 4 cm x 4 cm square box drawn to scale, to test the accuracy of your printed version. Measure the test box to confirm you have printed these drawings to the correct size. Your printer setting should be set at 'Scale 100%' or 'A4'.
Do not use if not to scale.

NZ Police Ammunition Danger Area Templates (ADAT) – 1:50000 Scale – T1 to T4

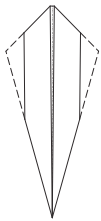

T1 - 22LR RIMFIRE RIFLES

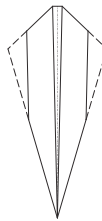

T1a - RIMFIRE PISTOLS

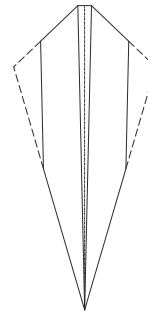

T2 - CENTREFIRE PISTOLS UP TO .50CAL

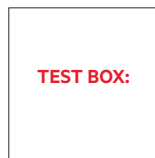

This is a 2 cm x 2 cm square box drawn to scale, to test the accuracy of your printed version. Measure the test box to confirm you have printed these drawings to the correct size. Your printer setting should be set at 'Scale 100%' or 'A4'.
Do not use if not to scale.

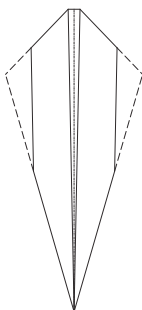

T3 - MUZZLELOADING AND PERCUSSION RIFLES

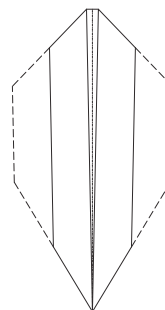

T4 - CENTREFIRE RIFLES UP TO .223 INCH/5.56MM

NZ Police Ammunition Danger Area Templates (ADAT) – 1:50000 Scale – T5 to T8

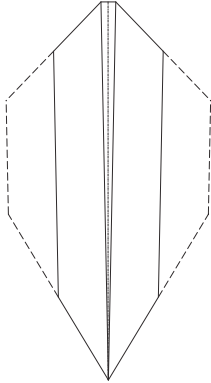

T5 - CENTREFIRE RIFLES UP TO .223 INCH/5.56MM

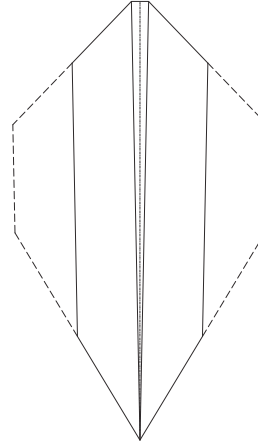

T6 - CENTREFIRE RIFLES .308 INCH/7.62MM UP TO 8MM



This is a 2 cm x 2 cm square box drawn to scale, to test the accuracy of your printed version. Measure the test box to confirm you have printed these drawings to the correct size. Your printer setting should be set at 'Scale 100%' or 'A4'.
Do not use if not to scale.

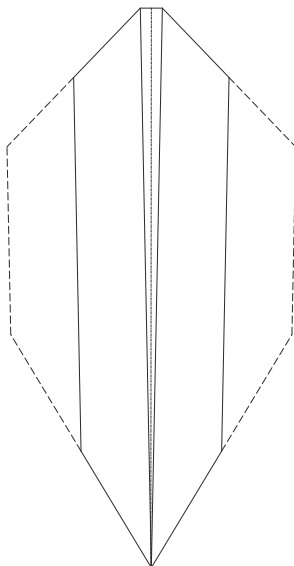

T7 - CENTREFIRE RIFLE .338 INCH

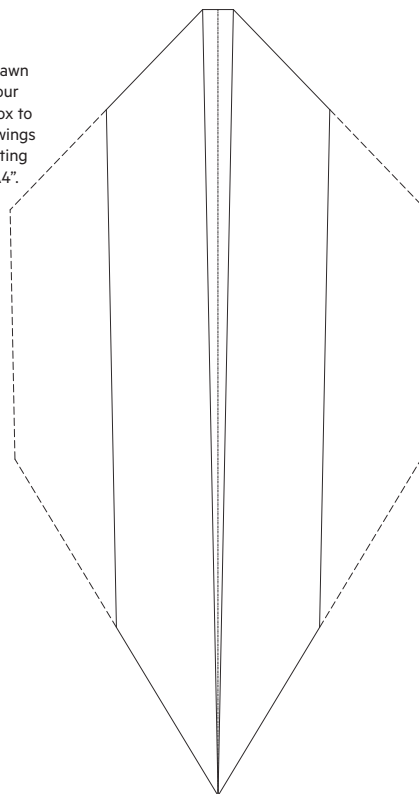

T8 - CENTREFIRE RIFLE .50 INCH