



Te Tari Pūreke
Firearms Safety Authority

New Zealand Police

Shooting Range Manual



V4.01

5 June 2026

Te Tari Pūreke – Firearms Safety Authority



icon design



About this manual

1. This manual contains the standards required by the Commissioner for the design, construction, and safe operation of shooting ranges in accordance with the Arms Act 1983 and the Arms Regulations 1992.
2. This version of the New Zealand Police Shooting Range Manual dated 5 June 2026 is approved by:
Inspector Peter (PGR) Baird
Manager Compliance
Te Tari Pūreke – Firearms Safety Authority
Acting under delegated authority of the Commissioner of Police.
3. This manual uses mandatory language such as ‘must’ and ‘is/are to’ in order to meet the required safety standards of the Arms Act 1983.
4. Examples of how to comply with the requirements, or recommendations for good practice, are indicated with non-mandatory language such as ‘may’, ‘should’, or ‘could’.

Table of Contents



PAGE		PAGE	
1	Preface	20	Section 3
2	Contents		Components of shooting range design and construction
4	Glossary of terms	20	Introduction
6	Figures and tables	20	Range design cone of fire (CofF)
7	Abbreviations	21	Range axis (direction of fire)
9	Section 1	21	Backstops
	Shooting ranges	23	Bullet catchers
9	Introduction	26	Mobile bullet catchers
9	Legislative requirements for shooting ranges	26	Side berms, side backstops and side walls
9	Legislative compliance requirements for shooting clubs and ranges	26	Side berms
9	Application/Submission/Notification forms	26	Side backstops
11	Section 2	26	Side walls
	Design and construction of a shooting range	27	Range floor
11	Design and construction of a shooting range	27	Baffles and protective cladding
11	Shooting range design guidance	27	Baffles
11	Shooting range design and construction techniques	27	Cladding
11	Generic shooting range design	29	Firing points and firing lines
11	Outdoor pistol/rifle shooting ranges	29	Spacing between shooters
13	Gallery range	29	Firing line height
14	Baffle range	29	Firing line depth
15	Shotgun ranges	29	Covered firing line
17	Indoor shooting range	29	Targets
18	Field shooting range	29	Target centre height
18	Black powder range	29	Target lines
		30	Moving targets
		30	Steel targets
		31	Steel target shrouds
		31	Canopy
		31	Environmental planning considerations
		31	Landowner consent
		31	Air danger height and airspace restrictions
		32	Airspace intrusion
		32	Indoor non-pistol shooting range design and construction
		32	Clay target (shotgun) shooting range design and construction
		32	Measuring a shooting range

34	Section 4 Shooting range danger areas signage and flags
34	Shooting range danger area definition
34	Shooting range danger area
34	Types of shooting range danger areas
34	No danger area
36	Full danger area
36	Range design cone of fire is not captured by an artificial structure or topographic feature
36	Reduced danger area
36	Pop-over
38	Effect of trees in shooting range danger areas
38	Activity inside a shooting range danger area - managing the risk
38	Determining a shooting range danger area
38	Impact surfaces
41	Selection and application of an ammunition danger area template
41	Ammunition danger area design explanation
47	Application of an ammunition danger area template
50	Technical guidance for shooting range certification and enrolment
50	Control of access to the range and the danger area
50	Shooting range signage
50	Shooting range entrance signage
51	Shooting range danger area signs
51	Alternatives to range danger area signs
52	Red warning flags
53	Alternative red warning flag requirements
53	Wind flags

55	Section 5 Range standing orders
55	Introduction
55	Risk assessment
55	Approval of RSOs
55	Notification of changes to RSOs
55	Notification to all range users
55	Range standing orders - contents/guide/template
56	Inability of a shooter to achieve and maintain the range design CofF
56	Range danger area description
57	Provision for restricted weapons, prohibited firearms and magazines
57	Individual shooting range summary sheet
63	Section 6 Shooting range closure
63	Shooting range closure
63	Temporary closure
64	Permanent closure
64	Decommissioning
66	Section 7 Zeroing (sighting-in/sight adjustment) conducted on private or public land
66	Zeroing (sighting-in/sight adjustment)
68	Section 8 References and acknowledgements
68	References
68	Acknowledgments
68	Range Certification Engagement Group

GLOSSARY

Active range area	The area in which shooting activity is conducted on a range, including the danger area applied to the range.
Quadrant Elevation (QE)	The Quadrant Elevation is the angle between the horizontal plane and the axis of the bore when laid (sighted).
Ammunition Danger Area Template (ADAT)	A template defines the area into which direct fire and ricochet is predicted to fall. An Ammunition Danger Area Template is a scale drawing encompassing the known ballistic characteristics of a given ammunition group, fired from a single firing point to a single target, in a single direction of fire (range axis). This drawing is then applied to a topographic map of the same scale to establish the range danger area.
Angular measurement	Angular measurements used in this manual are: <ol style="list-style-type: none"> 1. 360 degrees = 6400 NATO mils. 2. 1 degree = 17.77778 NATO mils. 3. 1 NATO mil = 0.05625 degrees.
Backsplash	Backsplash is defined as projectile fragments, target materials, or ground debris, thrown back towards the shooter as a result of projectile impact.
Calibre	The diameter of a firearm bore measured across the lands (excluding the depth of the rifling grooves) and the approximate diameter of a projectile.
Contour line	A line drawn on a map at a consistent height above mean sea level (AMSL) throughout its length that represents the three-dimensional shape of the ground.
Deterministic safety analysis	A traditional approach for developing an ammunition danger area applied to a range. It requires the calculation of a combination of predetermined factors to create a generic danger area. The ammunition danger area is applied from every firing position to every corresponding target position to calculate the overall range danger area.
Duty Officer(DO)/ Officer on Duty (OD)/ Range Officer (RO)	A person who holds a firearms licence and is appropriately trained in shooting range safety management. The Duty Officer (DO) may also be known as the Officer on Duty (OD) or Range Officer (RO).
High velocity	High velocity is a projectile that leaves the firearm at a muzzle velocity greater than 2,148 feet per second (fps).
Impact surfaces	Impact surfaces are all surfaces within the cone of fire that are likely to be struck. Impact surfaces are categorised as: <ol style="list-style-type: none"> 1. Hard impact surfaces include concrete, rock, steel, and frozen surfaces. 2. Ground impact surfaces are all surfaces other than hard impact surfaces. <p>The composition and depth of the ground (including topsoil and vegetation) in some regions may allow for the ricochet angle to be reduced if it is considered safe to do so by Clubs and Ranges.</p>
Low velocity	Low velocity is a projectile that leaves the firearm at a muzzle velocity no greater than 2,148 feet per second (fps).
Mantlet	A range structure on a gallery range that is designed to capture the bottom of the cone of fire.
Probabilistic safety analysis	Requires the collection and input of data within a probabilistic safety analysis software program recognised by Police. Danger areas calculated are specific to a range and may be smaller than those generated by deterministic safety analysis.

Range design cone of fire (CofF)	The cone of fire is the distribution of fired projectiles within a margin of error in the vertical and horizontal planes. Cone of fire is applied above, below and to either side of the point of aim and is critical in determining the design specification of a range.
Range axis (Direction of fire)	The primary bearing from which all range design geometry is derived. This is commonly referred to as the direction of fire.
Ricochet	A ricochet is the change of direction and velocity induced in a projectile or fragment caused by its impact with a surface. High velocity (greater than 2,148 fps) projectiles could ricochet up to 30 degrees off ground impact surfaces and 45 degrees off hard impact surfaces. Low velocity (up to 2,148 fps) could ricochet up to 15 degrees off ground impact surfaces and 45 degrees off hard impact surfaces. It is accepted that high velocity projectiles fired over long distances will lose velocity and may become low velocity projectiles, at which point a low velocity ricochet could occur off the impact surfaces described above.
Range Inspector (RI)	A person recognised by the Commissioner who can conduct shooting range inspections. This person must be a member of the Police and authorised in writing by the Commissioner. Only members of Clubs and Ranges will hold this written authority (previously known as a Shooting Range Inspector, or SRI).
Shooting Range Operator (SRO)	The person who is operating or proposing to operate a shooting range.
Temporary non-pistol shooting range	Is a non-pistol shooting range that is set up temporarily for no more than 2 shooting events in any calendar year, and lasts for no more than 4 days, with the first day being the day the event commences for participants.

FIGURES AND TABLES

FIGURE	TITLE	PAGE
2.1	Examples of pistol ranges	12
2.2	Examples of rifle ranges	12
2.3	Examples of gallery ranges	13
2.4	Examples of baffle ranges	14
2.5	Example of skeet ranges	15
2.6	Example of a down the line (DTL) trap (field) range	15
2.7	Example of a combined skeet and down the line (DTL) trapshooting (field) range with an ammunition danger area template applied to establish the range danger area	15
2.8	Example of a sporting clay shooting range with an ammunition danger area template applied to establish the range danger area	16
2.9	Example of a sporting clay shooting range	16
2.10	Example of indoor ranges	17
2.11	Example of field shooting ranges	18
2.12	Example of black powder shooting ranges	18
3.1	Example of a cone of fire around point of aim and target centre height dimension	20
3.2	Backstop slope	21
3.3	Backstop designed to capture cone of fire and range floor strike from first point of impact (FPI) and resultant ricochet	22
3.4	Bullet catcher construction dimensions	24
3.5	Video explaining how to measure components of a shooting range	32
4.1	Shooting range danger area decision flowchart	35
4.2	Cone of fire captured by a topographic feature with a slope of 56 deg or greater	36
4.3	Cone of fire captured by a topographic feature	37
4.4	Electronic application of an ADAT to produce a scale diagram of the range danger area with the reduced danger area indicated by the red bold line using the Microsoft PowerPoint software application.	37
4.5	Process flowchart - determining a shooting range danger area	39
4.6	Example of the components of an ammunition danger area template	42
4.7	1:25,000 T1 - T1a - T2 - T3 -T4 Templates	44
4.8	1:25,000 T5 - T6 Templates	45
4.9	1:25,000 T7 - T8 Templates	46
4.10	Examples of shotgun ammunition danger area templates	47
4.11	Example of a firing line with a left and right of arc	48
4.12	Example of template design for field shooting	48
4.13	Example application of an ammunition danger area template from a firing box using parallel bearings with a maximum left and right of arc applied	48
4.14	Example of a completed firing box using parallel bearings with maximum left and right of arcs	48
4.15	Air rifle 0.177 (up to 12ft lbs) outdoor full danger area template	49

4.16	Example of red warning flags and containment system	52
4.17	Example of signage	53
5.1	Example of the scale diagram of the range danger area and supporting information required for inclusion in RSOs (where applicable)	56
5.2	Example of RSOs individual range summary sheet	57

TABLE	TITLE	PAGE
3.1	Range design cones of fire	21
3.2	No danger area range backstop dimensions	23
3.3	Examples of bullet catcher maximum muzzle velocity (MV) and muzzle energy (ME)	24
3.4	Minimum thickness of construction materials	28
3.5	Minimum thickness of construction materials for sidewalls on outdoor ranges	28
3.6	Steel protective plating for ranges	28
3.7	Minimum thickness of construction materials for cladding	28
4.1	Steps required to determine a shooting range danger area	40
4.2	Ammunition Danger Area Template (ADAT) dimensions	43
5.1	Guide for the compilation and production of range standing orders	58-61
8.1	Range certification engagement group	68

ABBREVIATIONS

AofF	Arc of Fire	NDA	No Danger Area
ADH	Air Danger Height	OD	Officer on Duty
ADAT	Ammunition Danger Area Template	RCEG	Range Certification Engagement Group
CAA	Civil Aviation Authority	RI	Range Inspector
CofF	Cone of Fire	SRO	Shooting Range Operator
Deg	Degrees	RDA	Reduced Danger Area
DO	Duty Officer	RO	Range Officer
FDA	Full Danger Area	RSOs	Range Standing Orders
GB	Grid Bearing	s/w	Soft Wood
GR	Grid Reference	TCH	Target Centre Height
h/w	Hard Wood	MV	Muzzle Velocity
Mils	NATO mils (military angle of measurement)	ME	Muzzle Energy

Section

1



Target Line

Range Floor



Section 1

Shooting ranges



Introduction

- 1.1 This shooting range manual represents the standards required by the Commissioner for the design, construction, and safe operation of shooting ranges. The purpose of this manual is to provide design and construction criteria for shooting ranges, e.g., pistol, rifle, shotgun, and airgun shooting ranges.
- 1.2 The manual describes and explains:
 - a. The design and construction of shooting ranges.
 - b. The components of shooting range design and construction.
 - c. Shooting range danger areas, signage, and flags.
 - d. Range standing orders.
 - e. Shooting range closure.
 - f. Zeroing (sighting-in/sight adjustment).
- 1.3 Prior to planning and developing a new shooting range or making a significant change (affecting the ballistic characteristics) to an existing shooting range, it is recommended that contact is made with Clubs and Ranges for guidance and advice at this email address: ClubsandRanges@police.govt.nz.

Legislative requirements for shooting ranges

- 1.4 Information on the legislative requirements for shooting ranges can be found at [Te Tari Pūreke Firearms Safety Authority website/Manage and Apply/Clubs and Ranges](#).

Legislative compliance requirements for shooting clubs and ranges

- 1.5 Information on the legislative compliance requirements for shooting clubs and ranges can be found at [Te Tari Pūreke Firearms Safety Authority website/Manage and Apply/Clubs and Ranges](#).

Application/Submission/Notification forms

- 1.6 The forms required to administer the legislative requirements listed above can be downloaded from [Te Tari Pūreke Firearms Safety Authority website/Manage and Apply/Clubs and Ranges](#).



This range manual provides the New Zealand sport and target shooting community and members of the New Zealand public with the requirements for the design, construction, and safe operation of shooting ranges.



All ranges must be designed, constructed, operated, and maintained to ensure the safety of both participants and non-participants at the shooting activity

Section 2

Backstop

Side Wall

Side Wall

Range Floor

Bullet Catcher

Target Line

Slope Angle

34°

Minimum 30° (Critical)



Section 2

Design and construction of a shooting range



Design and construction of a shooting range

- 2.1 The key objective for the design and construction of a shooting range is that direct shots and ricochets are contained within the active range area (the area in which shooting activity is conducted on a range, including the danger area applied to the range). This is achieved by containing the cone of fire and any margin of error for the type of shooting activity carried out on the range.

Shooting range design guidance

- 2.2 This section sets out the core requirements and recommendations for the design and construction of a shooting range.

Shooting range design and construction techniques

- 2.3 The following information provides examples of shooting range design and construction techniques that can be used for a variety of shooting activities and may be customised for specific shooting disciplines. When developing this manual, national shooting organisation range manuals were used to reference range design and construction techniques specific to individual target shooting activities. These national shooting organisations are listed in section 8.

Generic shooting range design

- 2.4 A generic shooting range design provides a flexible framework suitable for multiple shooting disciplines, skill levels, and firearm types. Core components typically include firing points, firing lines, firing lanes, a range floor, a target line(s), a bullet catcher, a backstop, and a defined range danger area. Additional structures may incorporate covered firing points, target mechanisms, side berms, side walls, and baffles to enhance safety and functionality. All ranges must operate under approved and up to date range standing orders to ensure compliance and safe use.

Outdoor pistol/rifle shooting ranges

- 2.5 Outdoor pistol and rifle shooting ranges are designed for target shooting at various distances using pistol and rifle. Some ranges are designed for the use of both pistol and rifle, while others are for the use of pistol only or rifle only. Where a range is used for both pistol and rifle the ammunition danger area template for the largest approved calibre must be applied (unless a no danger area range). The following describes specific detail on each type of range:
- Pistol Shooting Range.** Any range on which a pistol is approved for use is defined as a Pistol Shooting Range and must have a valid pistol shooting range certificate to operate. A pistol shooting range is designed for firing pistols at soft (paper) or hard (steel) targets, and has a firing line(s), a target line(s), a bullet catcher, and a backstop. A pistol range may also have side backstops, side berms, side walls, a covered firing line, a covered target line, a canopy, and baffles. Ballistic range structures or features are designed and constructed to withstand the firing of low velocity firearms and ammunition unless the range allows for the use of high velocity ammunition (see figure 2.1).
 - Rifle Shooting Range.** Any range on which a rifle is approved for use is defined as a Non-Pistol Shooting Range and must be enrolled to operate. A rifle shooting range is designed for firing rifles at soft (paper) or hard (steel) targets. The range features and structures are generally the same as for pistol shooting ranges however; firing distances can range from 50 metres up to 1000 metres or more for field shooting rifle ranges. Ballistic range structures and features are designed to cater for the use of high velocity ammunition (see figure 2.2).



For additional information not contained in this manual, contact Clubs and Ranges at ClubsandRanges@police.govt.nz

Figure 2.1 – Examples of pistol ranges



Figure 2.2 – Examples of rifle ranges



Gallery range

2.6 A gallery range is an outdoor reduced danger area range, constructed in yards or converted fully or partially to metres, with firing lines typically spaced at 100 yard or 100 metre intervals, up to 1000 yards or metres. To apply the reduced danger area, the range must have compliant firing lines, range floor, mantlet, markers' gallery, and backstop. A common layout includes up to 12 firing lanes, each 4 metres wide. Targets are either manually scored by personnel in the markers' gallery or by an electronic target system (see figure 2.3).

Figure 2.3 – Examples of gallery ranges

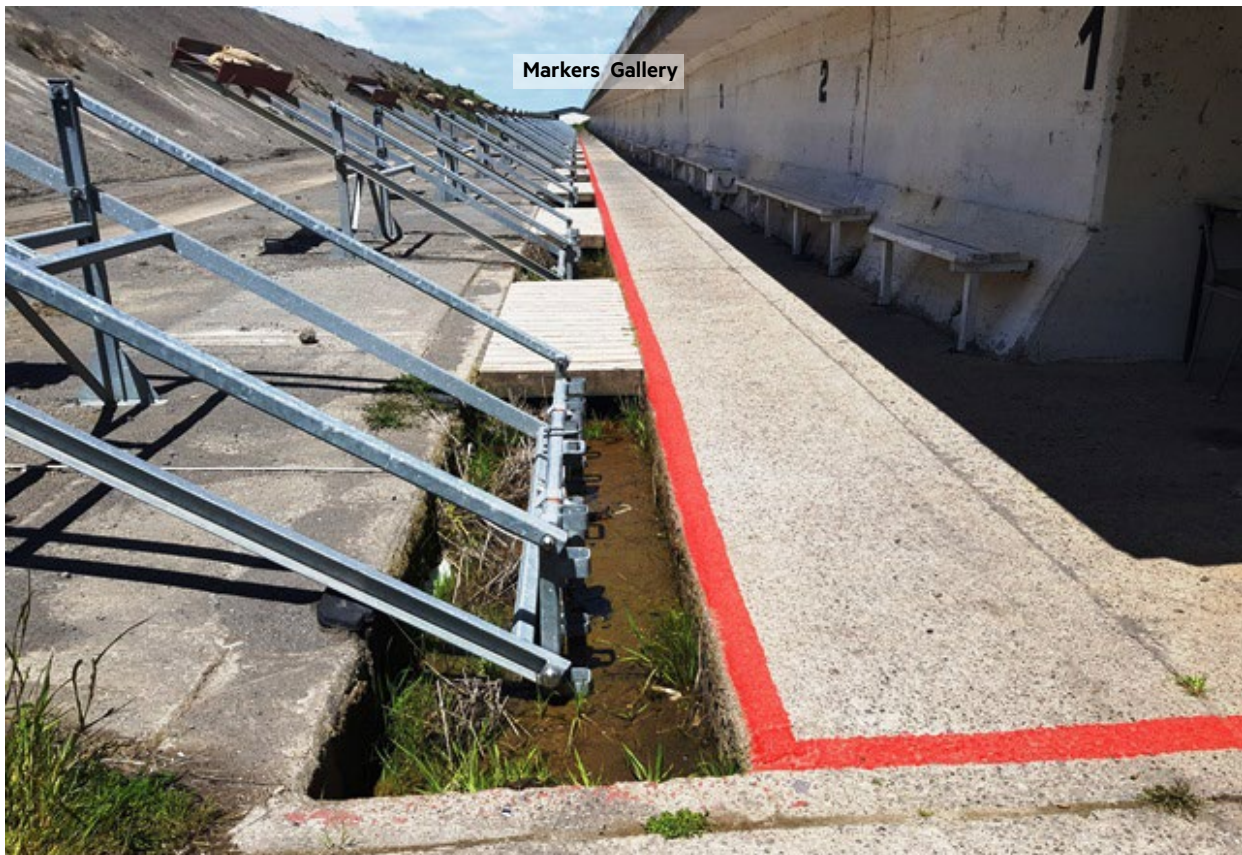

Baffle range

- 2.7 A baffle range may have baffles on either side of the range floor, above the range floor, on the range floor, or a combination of these. Baffles are used on ranges to ensure all correctly aimed shots and ricochets are contained (see figure 2.4) to prevent them from exiting the range. Construction materials of baffles and cladding must be appropriate for the ammunition to be used on the range and be regularly maintained (refer to tables 3.6 and 3.7 of section 3).

Figure 2.4 – Examples of baffle ranges

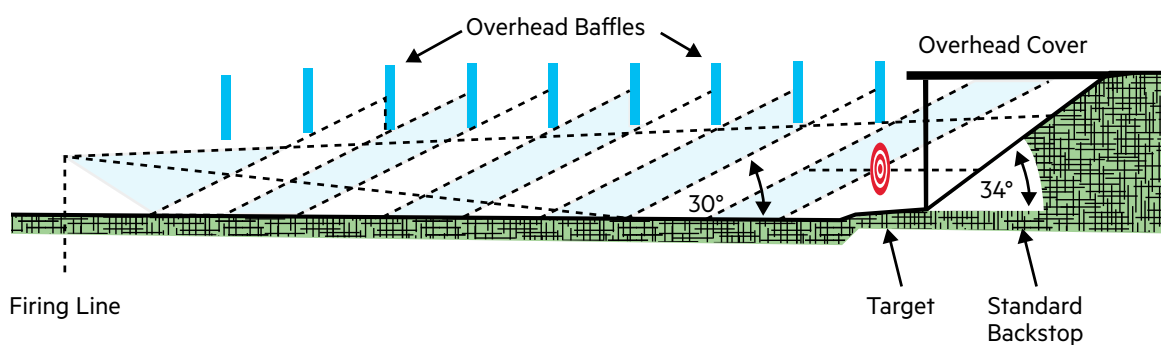
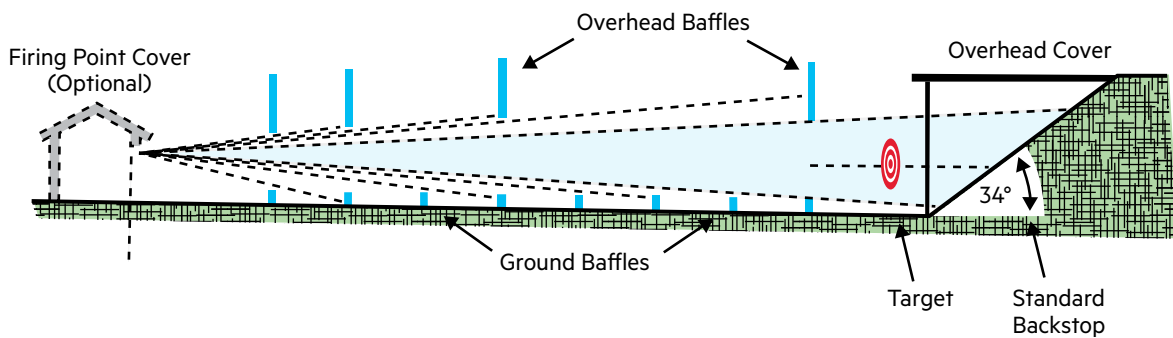
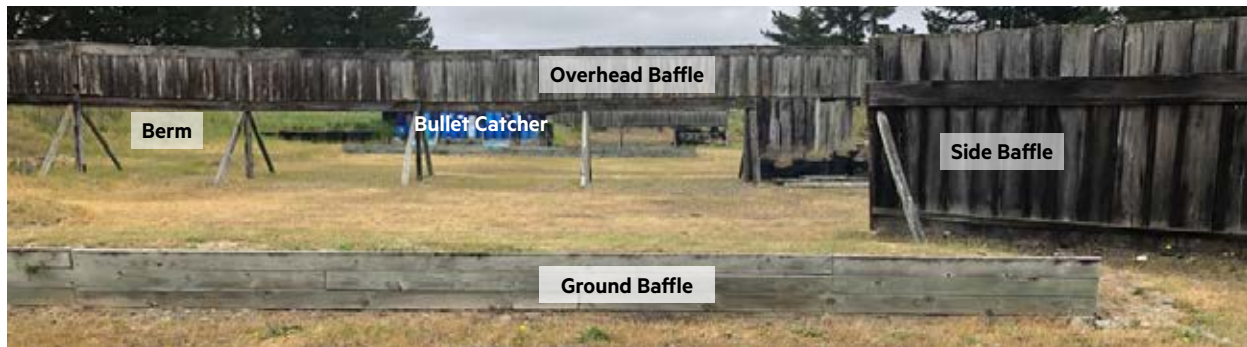

Shotgun ranges

2.8 Shotgun ranges have mechanical mechanisms (traps) to throw frangible targets (aerial clay targets) from an arrangement of shooting stations from which shooters engage these targets. The targets are thrown on fixed flight paths or within specified arcs. A shotgun range includes a downrange danger area (also referred to as a Shot Fall Safety Area), which is designed to contain all shot fired during shooting activities. The size of this danger area depends on whether steel or lead shot is used. Steel shot may be used to reduce the size of the required danger area or to comply with environmental consent conditions. Three types of shotgun ranges are:

- a. **Skeet and trapshooting range.** Skeet and trapshooting ranges are designed for firing shotguns at moving (aerial) clay targets. A range complex may combine Trapshooting and Skeet Ranges (also known as fields) in one layout and includes range structures required by the individual discipline. A range can consist of both a skeet field and a trapshooting field and will have a common danger area. Aerial clay targets are thrown on fixed flight paths or within specified arcs (see figures 2.5, 2.6 and 2.7). There are other types of trapshooting disciplines that can be conducted on a trapshooting range e.g., ball trap, running rabbit, sporting, kompak, and universal trench.

Figure 2.5 – Examples of skeet (field) ranges

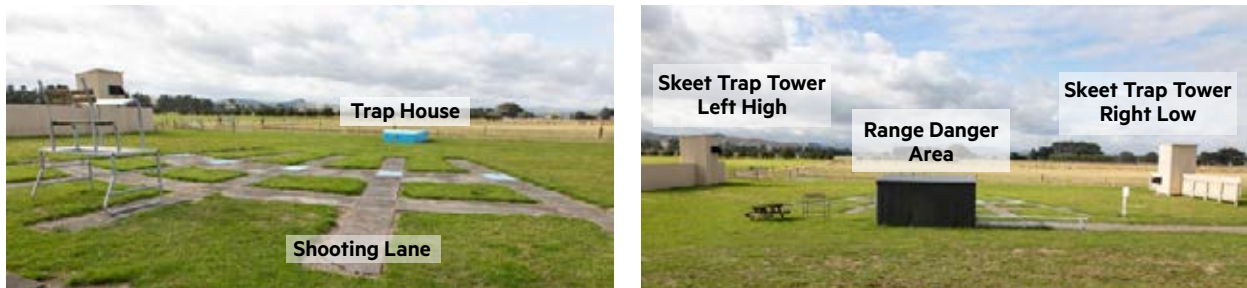

Figure 2.6 – Example of a down the line (DTL) Trapshooting (field) range



Figure 2.7 – Example of a combined skeet and down the line (DTL) trapshooting (field) range with an ammunition danger area template applied to establish the range danger area



- b. **Sporting clay range.** Sporting clay ranges are established with different shooting scenarios configured to simulate hunting-type settings. The typical sporting clay range consists of various shooting stations laid out in a circuit or configured around multi-station throwers. Each station consists of a shooting position that may include a shooting stall or frame, and a target thrower(s) designed to throw frangible aerial clay targets on a specific flight path or within specified arcs (see figures 2.8 and 2.9).

Figure 2.8 – Example of a sporting clay shooting range with an ammunition danger area template applied to establish the range danger area



Figure 2.9 – Example of a sporting clay shooting range



Indoor shooting range

2.9 Indoor ranges present ballistic and potential environmental considerations for the designer. The range building must contain all shot without causing damage or injury from ricochet or backslash. Environmental considerations include noise, particularly reverberation, airborne contaminants including lead and carbon monoxide pollution, and unburned propellant. Existing indoor ranges are generally designed with a maximum range of 25 yards or 25 metres, but purpose-built indoor ranges designed to meet specific requirements can be constructed. Traditional indoor ranges typically accommodate smallbore firearms, such as .22 inch (5.6 mm) rifles firing subsonic soft lead projectiles, and airguns using .177/.22 inch (4.5/5.58 mm) pellets. A traditional range will usually consist of firing lines (or mounds), an unobstructed range floor, a target line, a bullet catcher, back plate, and defence zone (see figure 2.10).

Figure 2.10 – Examples of indoor ranges

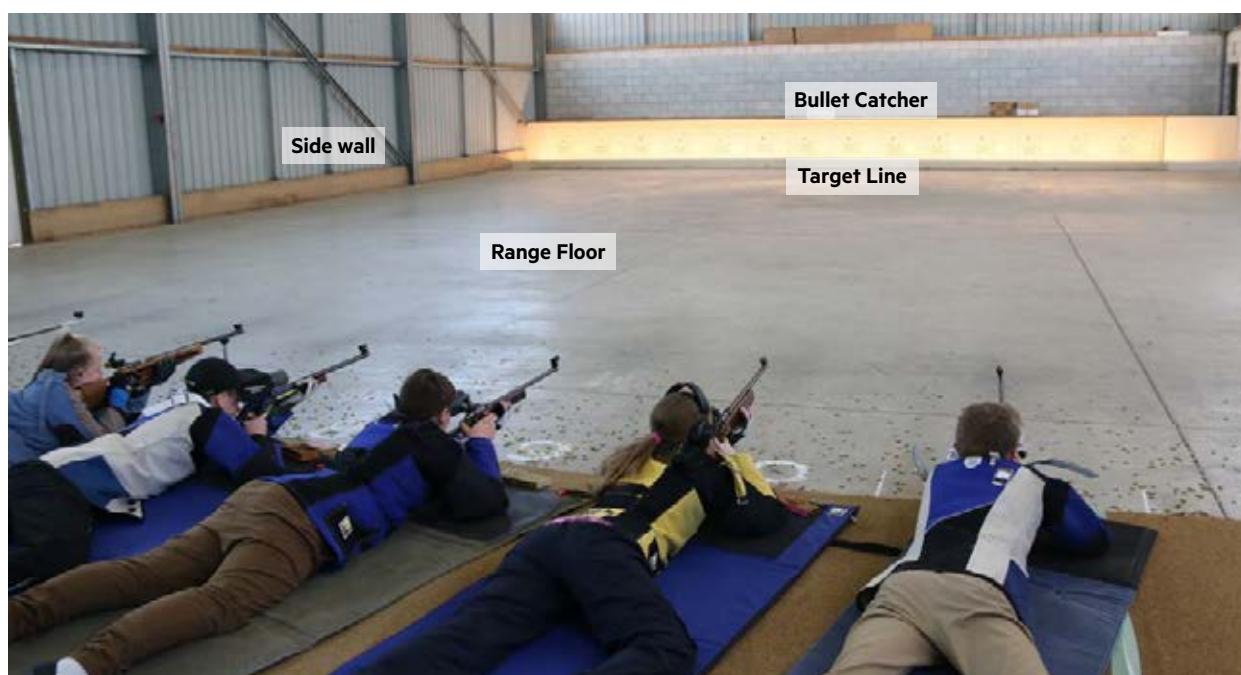
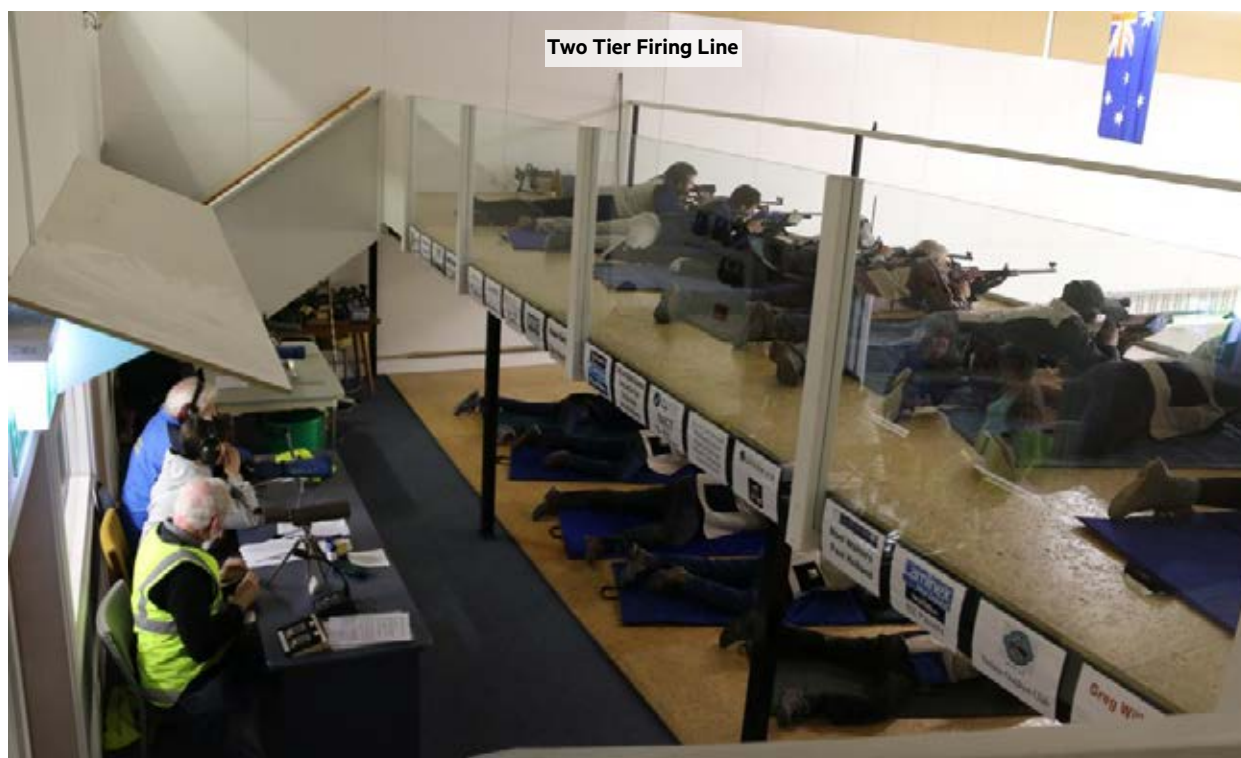

Field shooting range

2.10 Field shooting ranges are designed to replicate outdoor environments through varied shooting scenarios. These ranges typically feature a circuit of shooting stations, each positioned to engage designated target locations. Stations may include shooting positions with facades or rests to simulate realistic field conditions. Infrastructure is usually minimal or absent, with the range being set up prior to use and dismantled afterward. The locations of any compliant topographic features plays a key role in determining the type of danger area to be applied (see figure 2.11).

Figure 2.11 – Example of field shooting ranges



Figure 2.11 – Example of field shooting ranges

Black powder range

2.11 Whilst black powder firearms (including black powder mortars and canons) can be used on most outdoor ranges if approved by a range operator, a black powder range is designed for specific black powder shooting activities. These activities include muzzle loading and black powder cartridge firearms shooting at static and moving targets. The location and any compliant topographic features plays a key role in determining the type of danger area to be applied. Range features may include firing lines, firing lanes, a target line, a bullet catcher, a backstop, and a danger area (see figure 2.12).

Figure 2.12 – Example of a black powder shooting ranges



Section

3

Side Wall



Section 3

Components of shooting range design and construction



Introduction

3.1 A shooting range is designed to accommodate the largest firearm calibre and ammunition type approved for use on the range. This section outlines principles from the New Zealand shooting community and international best practices, along with key features and components for the design and construction of shooting ranges.

Range design cone of fire (CofF)

3.2 The cone of fire is the distribution of fired projectiles within a margin of error in the vertical and horizontal planes (see figure 3.1). For design purposes the CofF is applied from the firing point/line to the target centre. The CofF accounts for acceptable deviation caused by errors associated with the firer, machining or manufacturing tolerances of the firearm and ammunition, and allows an additional margin for unacceptable firer error (see figure 3.3). For shotguns firing 'shot', shot-spread is used instead of CofF. Shot-spread must be directed within the designated arcs of fire to ensure all shot is contained within the range danger area for the shooting activity.

3.3 The range design cones of fire listed in table 3.1 are applied from a distance no greater than 100 metres as follows:

- For ranges with a single firing line, but several target lines, the cone of fire shall have its origin at the firing line.
- For ranges with a single target line, but several firing lines, the cone of fire shall have its origin at the firing line furthest (but not greater than 100 metres) from the target line.

3.4 The shooter must demonstrate at close range their ability to achieve the range design CofF to the satisfaction of the Duty Officer/Officer on Duty/Range Officer, before progressing to greater shooting distances. This procedure is to be detailed in range standing orders.

3.5 Any variation to the range design cones of fire listed in table 3.1 must be approved by Clubs and Ranges.

Figure 3.1 – Example of a cone of fire around point of aim and target centre height dimension

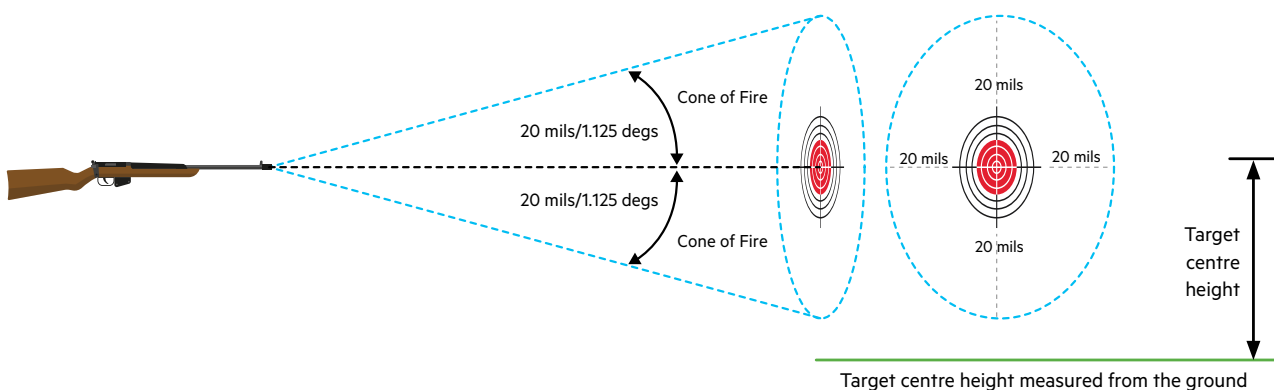

Table 3.1 – Range design cones of fire (see note)

Range	Cone of fire	Comment
Pistol range	23 mils (1.29 deg)	All pistol shooting disciplines
Outdoor rifle range	20 mils (1.125 deg)	Includes black powder rifle and shotguns firing solid slugs
Indoor/Outdoor small-bore rifle and airgun range	10 mils (0.563 deg)	

Note: Refer to paragraph 3.5

Range axis (direction of fire)

3.6 The range axis can be measured by obtaining a bearing from a compass or global positioning system (GPS) in the direction of fire and plotting it onto a map as a grid bearing. This bearing is used as the range axis to determine the range design geometry and range danger area.

Backstops

3.7 The backstop is the area extending above and to the sides of the bullet catcher and should be subjected to lesser concentrations of fire. Its purpose is to stop direct shot in free flight and ricochet from the predicted first point of impact. Typical backstop construction methods include vertical walls, natural earth embankments, purpose-built structures, or cuttings into an existing hillside.

3.8 For criteria for a no danger area range backstop refer to table 3.2 of this section.

3.9 For criteria for a reduced danger area backstop refer to paragraph 4.9 of section 4.

3.10 Backstops are not required for full danger area ranges.

3.11 Where practicable, a backstop is to be established parallel to the firing line(s), target line(s), and bullet catcher; however a maximum deviation of 10 degrees from the range axis is permitted.

3.12 The backstop may be constructed of a solid inert core material; however, the forward slope must be covered by suitable fill material (e.g., sand, soil, or aggregate) as follows:

- a. **Low velocity** - Fill material depth behind targets is to be no less than 500 mm measured parallel to the line of fire.
- b. **High velocity** - Fill material depth behind targets is to be no less than 900 mm measured parallel to the line of fire.

3.13 The forward slope of the backstop is to be established at no less than 34 degrees. This slope may reduce over time with natural settlement of the fill material, projectile impact, tunnelling, and weathering. The slope must not be permitted to drop below 30 degrees; if it does, it must be restored to 34 degrees (see figure 3.2).

3.14 Vegetation (grass, shrubs, and trees) is not to be considered when calculating the height of a backstop.

Figure 3.2 – Backstop slope

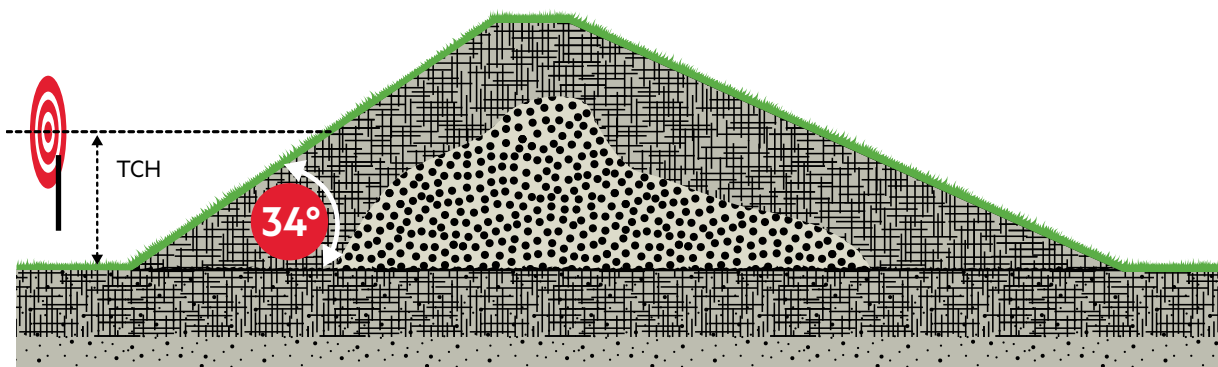

Figure 3.3 - Backstop designed to capture CofF and range floor strike from the first point of impact (FPI) and the resultant ricochet

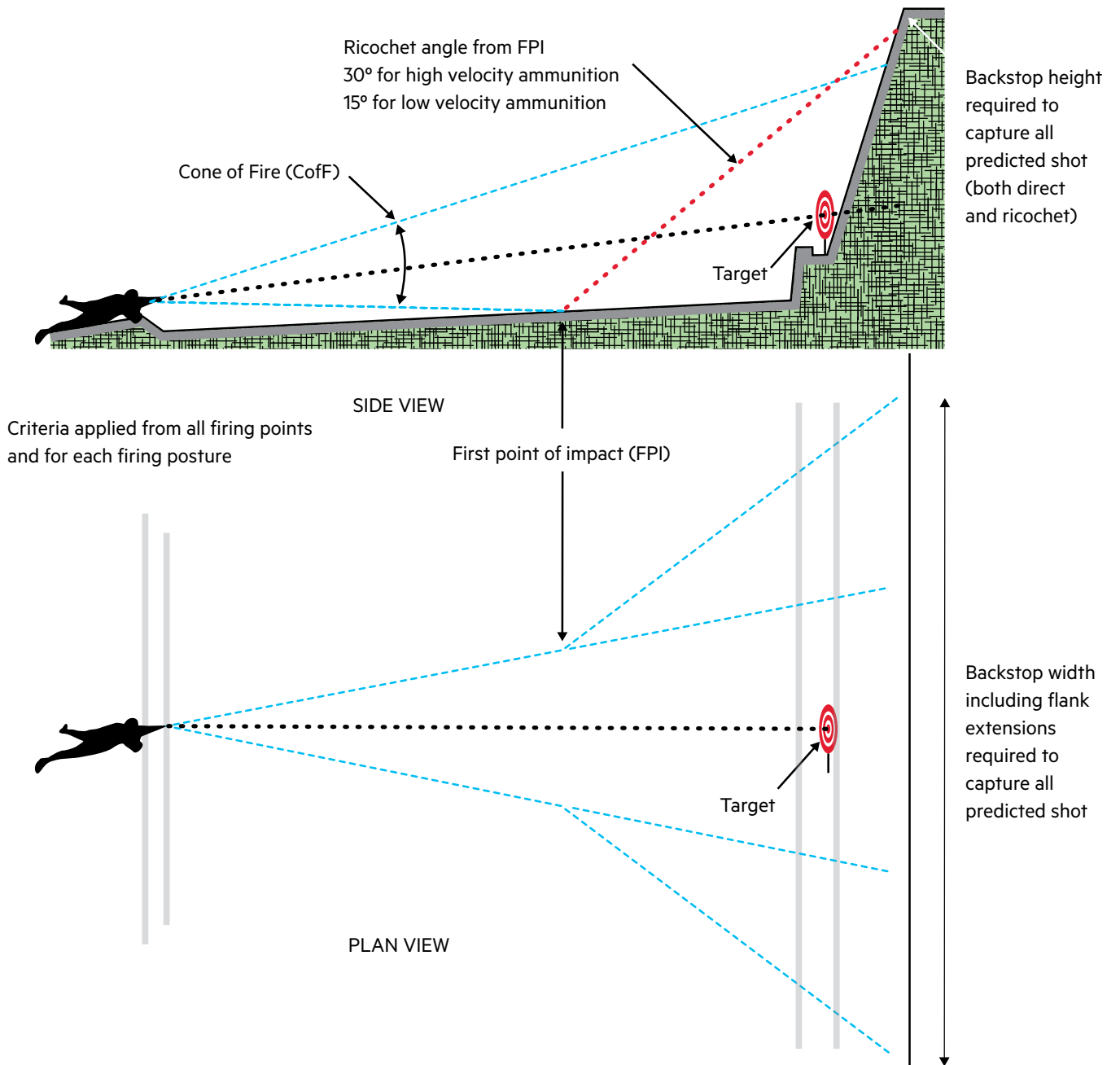

Table 3.2 – No danger area range backstop dimensions

Outdoor/indoor no danger area (NDA) range backstop dimensions - airgun/rimfire (up to a firing distance of 100 metres; for firing distances over 100 metres refer to section 4)								
Indoor airgun/rimfire				Outdoor 0.22 LR rimfire rifle				
Firing distance to target line (m)	10	25	TCH	Firing distance to target line (m)	≤ 25	50	75	100
Single (1) tier firing mound – (1 m in height from range floor)				Height (m)	2.5	3.5	4.0	4.5
Height (m)	1.5	1.5	1	Flank extension beyond target (m)	1.0	1.5	2.0	2.5
Two (2) tier firing mound - (3 m in height from range floor)				Backstop depth (at crest) no less than 500 mm Impact surface - No exposed hard objects within the Coff excluding the target Condition = No degradation or scooping				
Height (m)	3.5	3.5	3					
Flank extension beyond target (m)	0.5	0.5						

Note: These dimensions may be adjusted to match the dimensions of existing indoor range structures, e.g., actual firing mound heights (refer to tables 3.4 and 3.6 for dimensions of indoor backstop materials). Centrefire pistol may be fired in an indoor NDA range specifically designed/constructed for that purpose.

Outdoor NDA range backstop dimensions for centrefire pistol/rifle (For firing distances over 100 metres refer to section 4)											
Pistol				Rifle							
Firing distance to target line (m)	≤ 10	15	25	50	75	100	Firing distance to target line (m)	≤ 25	50	75	100
Height (m)	2.5	3.0	5.0	7.0	9	12	Height (m)	4.0	5.0	6.0	7.0
Flank extension beyond target (m)	1.0	1.0	1.5	2.0	2.5	3.0	Flank extension beyond target (m)	1.0	1.5	2.0	2.5
Backstop depth (at crest) no less than 600 mm Impact surface - No exposed hard objects within the Coff excluding the target Condition = No degradation or scooping							Backstop depth (at crest) no less than 900 mm Impact surface - No exposed hard objects within the Coff excluding the target Condition = No degradation or scooping				

Note 1: Flank extension is measured from the outermost flank target (to the left or right of the target line).

Note 2: Overall heights have been calculated allowing for primary firing postures of prone, kneeling and standing.

Note 3: Height is calculated for the furthest firing line from the target line with the toe of the backstop being no further than 3.5 metres from the target line.

Note 4: NDA backstop height is based on the elimination of range floor strike forward of the target line. If range floor strike occurs the SRO is to consider additional control measures for ricochet capture, such as a canopy, construction of baffles, or adjustment to the TCH or the height of the firing point/line in order to maintain a NDA range status.

Bullet catchers

3.15 Although optional, it is recommended that NDA ranges have a purpose-built bullet catcher. The bullet catcher is the area directly behind the furthest target line. The purpose of the bullet catcher is to capture the majority of correctly aimed shots fired at a target. A bullet catcher may be a standalone structure or part of a backstop. Bullet catchers may be used to:

- Minimise degradation of the backstop (e.g., loss of slope angle).
- Minimise backstop maintenance.

3.16 Where practicable, a bullet catcher is to be established parallel to the firing line(s) and the furthest target line. However, a maximum deviation of 10 degrees from the range axis is permitted.

3.17 The bullet catcher may be constructed of a solid inert core material; however, the forward slope must be covered by suitable fill material (e.g., sand, soil, or aggregate) as follows:

- Low velocity** - Fill material depth behind targets is to be no less than 500 mm measured parallel to the line of fire.

- b. **High velocity** - Fill material depth behind targets is to be no less than 900 mm measured parallel to the line of fire.
- c. Refer to table 3.3 for examples of bullet catcher maximum muzzle velocity (MV) and muzzle energy (ME) limitations.

3.18 The forward slope of a bullet catcher:

- a. For high velocity ammunition, is to be established at no less than 34 degrees. This angle may reduce over time with natural settlement of the fill material, projectile impact, tunnelling, and weathering. The slope must not be permitted to fall below 30 degrees; if it does, it must be restored to 34 degrees (see figure 3.4).
- b. For low velocity ammunition (only), is to be established at no less than 20 degrees. The slope must not be permitted to fall below 15 degrees; if it does, it must be restored to 20 degrees. If the bullet catcher is combined within the backstop, the slope angle of the backstop must be maintained at 34 degrees.

3.19 If rubber chip is to be used as a fill material, it should be shredded rubber chip that has no steel belt fragments. The rubber chip should be of a regular shape and sized 10 - 25 mm in any direction allowing it to interlock. Rubber presents a potential fire hazard; however, it can be sprayed with a fire-retardant compound. Repeated projectile impact will wear down the rubber to a powder creating a fire hazard and it will need to be maintained.

3.20 Plastic drums (or other fit for purpose structures) may be used as a permanent bullet catcher where they can be positioned or constructed to achieve the requirements of a bullet catcher.

3.21 The bullet catcher must be no less than 2.5 metres in height and must extend above the maximum target height by no less than 0.5 metres for the total width of the target line (see figure 3.4).

3.22 Maintenance of the bullet catcher is an important aspect for the safe operation of a range. Regular checking and refurbishment of the bullet catcher is to be included in the range maintenance schedule.

Figure 3.4 – Bullet catcher construction dimensions

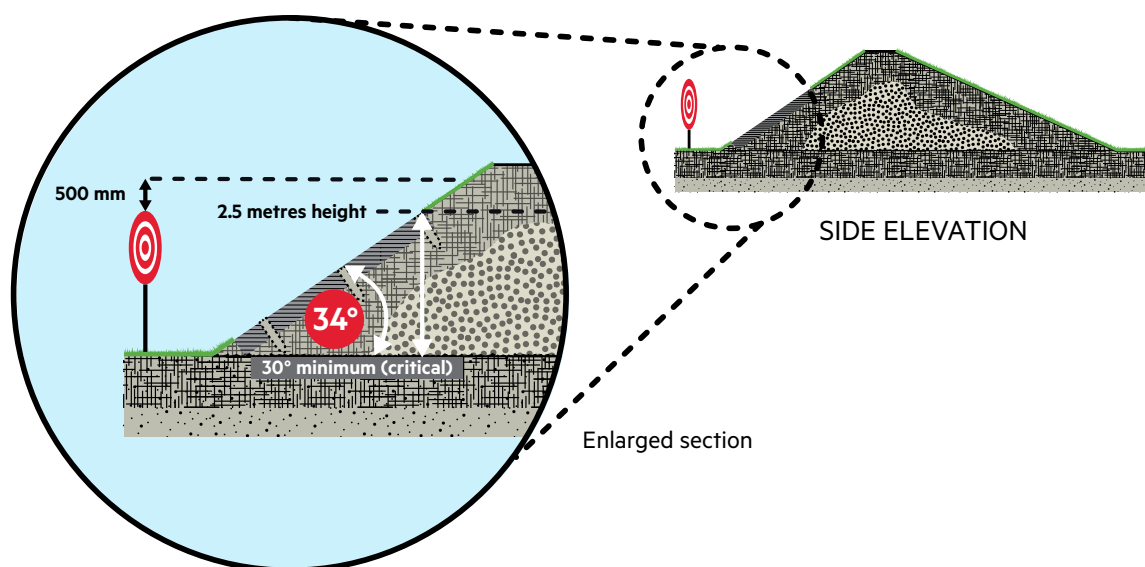

Table 3.3 – Examples of bullet catcher maximum muzzle velocity (MV) and muzzle energy (ME)

Indoor ranges	(m/s) MV	Joules ME	Outdoor ranges	(m/s) MV	Joules ME
Rimfire pistol or rifle	530	285	Rimfire pistol or rifle	610	480
Centrefire pistol	520	645	Centrefire pistol	655 (2148fps)	2030
Centrefire rifle (NDA)	1000	4500	Centrefire rifle (NDA/RDA)	1000	7000
No requirement for limitation during field shooting					

Note: 1. To maintain a bullet catcher in a serviceable state, range standing orders must detail the maximum permissible firearm muzzle velocity or energy to be used on the range.



Mobile bullet catchers

3.23 The SRO is to approve the use of mobile bullet catchers on the range and is to ensure that the bullet catcher will capture all ammunition used. The Officer on Duty is to check that the mobile bullet catcher is fit for purpose prior to use. For targets that are positioned on the range floor at locations other than at the bullet catcher/backstop/side backstop, they should be large enough to capture the cone of fire for the distance being fired. The most common mobile bullet catcher currently in use is a 200 litre (blue) plastic drum filled with suitable material. Other appropriate forms of mobile bullet catcher may be used.

3.24 For plastic drums, recommended modifications are:

- a. Prepare the drum to allow ease of filling.
- b. Fill with appropriate material that will capture ammunition. Examples are:
 1. **Conveyor belt** – the belt material must be at least three layers thick around the complete circumference of the drum. Depending on the width of the conveyor belt it may need to be stacked two layers high inside the drum.
 2. When using other types of fill material such as rubber chip, sawdust, sand or soil, the drums must be filled to the top and regularly maintained.
- c. Soft targets must be placed on the lower half of the drum.
- d. Steel targets must be placed directly in front of the drum.

Side berms, side backstops and side walls

3.25 The use of side berms or side walls is not mandatory where there is no risk to the users of adjacent ranges, and the range danger area is contained within the approved boundary of the range. However, on ranges that do have side berms or sidewalls, they may have been constructed for one or more of the following reasons:

- a. To prevent movement of people or animals onto the active range area.
- b. To reduce the likelihood of an errant shot, ricochet, backsplash, or splatter escaping the active range area.
- c. To separate adjacent ranges and protect people in areas adjacent to the range.
- d. To protect buildings or equipment (e.g., a target shed).

Side berms

3.26 If side berms are used, they are for down range shooting only and they are to:

- a. Be no less than 2.1 metres high measured from the range floor.
- b. Have a slope no less than 34 degrees.
- c. Have a crest depth of no less than 600 mm.
- d. Meet the following:
 1. Connect to the backstop where practicable; and
 2. Be continuous, without gaps, unless:
 - (a) The gap contains a structure that does not compromise the purpose of the side berm (e.g., an access gate or target shed); and
 - (b) The gap does not present a ballistic risk.

3.27 Tyres may be used in the construction of side berms or as a method to increase their height. If tyres are used for these purposes, they should be:

- a. Stacked staggered and overlapped to provide uniform, gap-free coverage.
- b. Cut away on one side and filled with soil or sand that is firmly compacted. Fill material may not be required if the tyres can be stabilized, e.g., with conveyor belt material secured to the tyres.
- c. Tyres used for the purpose of increasing the height of a side berm may not require filling if securely supported and configured to prevent toppling, sagging, or leaning.

Side backstops

3.28 If any section of a side berm or the complete length of a side berm is to be shot into (direct impact), then the side berm must meet the construction requirements of a backstop and therefore is to be known as a side backstop (refer to para 3.7). The height must be increased to be no less than 2.5 metres as measured from the range floor which is the minimum no danger area backstop height at a firing distance of no more than 10 metres.

Side walls

3.29 A side wall can only be used as a side backstop when an approved mobile bullet catcher is used and positioned correctly to capture all direct impact or ricochet.

3.30 A side wall must be vertical and be no less than 2.1 metres high measured from the range floor. They should be constructed of materials as set out in table 3.5. They should meet the following:

1. Connect with the backstop where practicable.
2. Be continuous without gaps unless:
 - a. The gap has a structure that does not compromise the purpose of the side wall, e.g., access gate or target shed; and
 - b. The gap does not constitute a ballistic risk.

Range floor

- 3.31 The range floor is defined as the space between the furthest firing point or line and the most distant target point or line. Where practicable, the surface should be reasonably level, firm, and free-draining to prevent ponding, and it should have a minimum of 150 mm of soil cover that is free of stones larger than 30 mm in any direction. Grass is the most common top cover; however, there are other acceptable materials. Particular attention is needed to cover or remove any exposed hard surfaces within the cone of fire. The range floor should not contain any standing bodies of water (e.g., lake, river or stream) that projectiles could be fired into, unless a berm or ground baffle is in place to prevent impact. Field shooting range floors are natural features that must allow clear line of fire to the target.

Baffles and protective cladding

- 3.32 Baffles are constructed and positioned to prevent projectiles from escaping the active range area. The projectiles may be direct impact or ricochets. If baffles are constructed of hard material such as steel, protective cladding must be attached to baffle surfaces or other hard surfaces that are expected to be struck to reduce backsplash. Protective cladding should be checked for serviceability and hidden attrition (unseen degradation of the base material covered by the cladding) as part of the range maintenance schedule. Baffles can be constructed on the ground, on side walls and overhead.

Baffles

- 3.33 It is recommended that the SRO seeks advice from Clubs and Ranges for the siting of all types of baffles. For the construction materials and dimensions, refer to tables 3.4 and 3.6.

Cladding

- 3.34 Material used for cladding should allow penetration of the projectile to the baffle and contain all resultant backsplash. The cladding material must be offset from the hard surface to allow the bullet to break up on the hard surface without causing excessive damage to the cladding. Refer to table 3.7.



Table 3.4 – Minimum thickness of construction materials

Minimum thickness (mm) of construction materials considered impenetrable to direct bullet strike for indoor and outdoor ranges				
Ammunition	Concrete (40 MPa)	Timber casing (see note 2)	Concrete Block	Timber (see note 3)
0.22 LR Rimfire	75	50 timber either side with a 300 fill	100	125 h/w or 175 s/w
Centrefire pistol	150	50 timber either side with a 500 fill	215	175 h/w or 200 s/w
Centrefire rifle	200	50 timber either side with a 1000 fill	230	250 h/w or 375 s/w

Note: 1. A combination of materials or newly developed fabrics of various dimensions may be used subject to review and approval by Clubs and Ranges.

Note: 2. Fill material dimensions are dependent on the type of fill.

Note: 3. Hard Wood (h/w) and Soft Wood (s/w).

Table 3.5 – Minimum thickness of construction materials for sidewalls on outdoor ranges

Minimum thickness (mm) of construction materials for sidewalls on outdoor ranges (see note 1)				
Ammunition	Concrete (40 MPa)	Timber casing (see note 2)	Concrete Block	Timber (see note 3)
0.22 LR Rimfire	N/A	N/A	50	50 s/w
Centrefire pistol	75	50 timbers either side with a 75 fill	100	150 s/w
Centrefire rifle	100	50 timbers either side with a 100 fill	230	250 h/w or 375 s/w

Note: 1. A combination of materials or newly developed fabrics of various dimensions may be used subject to review and approval by Clubs and Ranges.

Note: 2. Fill material dimensions are dependant on the type of fill.

Note: 3. Hard Wood (h/w) and Soft Wood (s/w).

Table 3.6 – Steel protective plating for ranges

Protective steel plating (mm) for indoor/outdoor ranges		
Ammunition	Defence zone/Baffles	Bullet catcher - Direct Impact
0.22 LR Rimfire	5 direct - 3 flank	6 mild - 4 armoured
Centrefire pistol	6 direct - 5 flank	8 mild - 6 armoured
Centrefire rifle	12 direct - 8 flank (see note 1)	See note 2

Note: 1. Minimum recommended abrasive resistant (AR) steel grade with a Brinell Hardness for centrefire rifle is AR500 (or equivalent).

Note: 2. It is recommended that design advice specific to the range is obtained from Clubs and Ranges.

Table 3.7 – Minimum thickness of construction materials for cladding

Minimum thickness (mm) of construction materials for cladding			
On all ranges exposed hard surfaces must be protected from direct fire to prevent backsplash and ricochet. Traditionally, sacrificial timber is added to the face of hard surfaces and steel baffles to prevent backsplash and excessive ricochet, but other materials may be just as suitable (see note 1).			
Ammunition	Sacrificial Timber (s/w)	Conveyor Belt	Battens (s/w) – Offset Spacing (see notes 2 and 3)
0.22 LR Rimfire	25	8	25
Centrefire pistol	50	12.5	50
Centrefire rifle	50	12.5	50

Note: 1. A combination of materials or newly developed fabrics of various dimensions may be used subject to review and approval by Clubs and Ranges. Cladding is not required on a hard surface that is not within the cone of fire for down range shooting.

Note: 2. Battens are only used for direct impact surfaces or baffles, they are fixed to the hard surface and the cladding material is fixed to the batten.

Note: 3. The cladding material used must prevent backsplash or ricochet off the hard surface. To reduce attrition, the protection material is offset from the hard surface by the use of battens to allow the bullet to break up on the hard surface without causing excessive damage to the protection material.

Firing points and firing lines

- 3.35 Firing points and lines are designated locations on the range floor established at specific distances where firing takes place. They are designed to provide the shooter with a level platform (sometimes elevated) with a clear view and unobstructed line of fire to their target(s) or target lines.
- 3.36 Firing points and lines should be established at right angles to the range axis (direction of fire) and where possible parallel to the target line.
- 3.37 Firing points and lines should be marked with the designated firing distance to ensure all range users can clearly identify the correct location of the firing point and line.
- 3.38 An adjustable shutter or 'eyebrow' may be positioned at some firing points or lines. Its purpose is to restrict the shooter's line of sight above the top of the backstop and prevent the firearm barrel from being raised beyond the maximum approved quadrant elevation, which could otherwise allow a projectile to leave the range danger area.

Spacing between shooters

- 3.39 Firer position spacing is measured centre-to-centre between adjacent firer positions. The spacing of firer positions along the firing line should be such that:
- Shooters do not cause unnecessary distraction to each other during firing e.g., being hit by ejected cases.
 - The Officer on Duty can maintain control of the range.

Firing line height

- 3.40 Where practicable, and depending on the range design and its intended use, firing points and firing lines can be elevated above the range floor. This elevation improves visibility of the target area, and should be constructed to provide for the safe movement of shooters.
- 3.41 Elevating the firing point or firing line may also have the effect of removing the range floor from the cone of fire (a similar effect to sloping the floor toward the target area). If multiple elevated firing points and firing lines are provided on a range, range design must ensure that firing points positioned in front of other firing points and firing lines do not interfere with a shooter's line of sight or create an unacceptable ricochet hazard.

Firing line depth

- 3.42 Firing line depth is the distance measured from the front edge of the firing line to the rear edge of the firing line. Each firing line must be deep enough to accommodate the shooters and their equipment and provide space for the Officer on Duty (or any other designated range safety person) to function behind them without any obstructions. The recommended firing depth is a minimum of 2.5 metres.

Covered firing line

- 3.43 The firing line may be covered with a weather shelter. The height and construction must not interfere with the shooters or the Officer on Duty during any part of their activities on the firing line e.g., preparation, firing, or supervision. The firing point cover must not obscure the view of the active range area from the shooters or the Officer on Duty.

Targets

- 3.44 Targets can be constructed of various penetrable materials such as paper, cardboard, core-flute and thin plywood. Non-penetrable or steel targets are covered in paragraph 3.52. Correct target positioning is critical to ensure projectiles are contained within the range danger area. Targets should be presented facing directly towards the firing point/line and shooter. Targets can be presented using various types of target support mechanisms; however, any support mechanism constructed of ricochet inducing material should be clad with sacrificial material on all forward-facing surfaces.

Target centre height

- 3.45 Targets should be set at such a height that projectiles are captured by the centre of the bullet catcher or the main impact area of the backstop.
- 3.46 The target centre height depends on the physical structures of the range and should enable a near level line of fire, although there are circumstances that may require either elevated or depressed lines of fire (uphill or downhill shooting).

Target lines

- 3.47 A target line is the area where a single target or several targets are positioned. This area can be a marked line on the range floor or have target support mechanisms such as in ground sockets to support target placement. The target line should be located as close to the toe of the bullet catcher or backstop as possible.

3.48 Intermediate target lines may be established between the furthest static firing line and the main target line. The target centre height must be adjusted to ensure that aimed shots at these target lines will remain within the range design cone of fire and be captured by the bullet catcher or backstop.

3.49 A target line should always be established at a right angle to the range axis (direction of fire). The target frames and support mechanisms made of ricochet inducing materials exposed to direct impact are to be clad with sacrificial timber or lined with material that will reduce the potential for ricochet. Tyres used in the construction of target lines or to support target presentation, are also to be clad with sacrificial timber or lined with another suitable material, or alternatively dug in where possible.

Moving targets

3.50 Moving targets are those targets that move across the static target line of the range or are presented to a height that does not compromise the purpose of the bullet catcher or backstop, e.g., running board, vertical can, and clay bird target launchers. This does not include purpose-built clay bird target traps or reactive static steel targets, e.g., poppers, drop turners, or swinging targets.

3.51 For ranges where moving targets are used, the design of the range and application of the ammunition danger area template must be considered. The maximum left and right limits of the target run (traverse) must be clearly marked or indicated on the target line, so that shooters can identify the approved arc of fire (AofF) within which the moving target may be engaged.

Steel targets

3.52 For shooting activities where steel targets are used, the provisions of the most current version of the [Pistol New Zealand Steel Target Safe Use Guide](#) is to be used.

3.53 There are two types of steel targets generally used for target shooting:

- a. **Reactive** – these targets can react by falling forward, spinning, or swinging when struck, e.g., poppers.
- b. **Non-reactive (rigid)** – these targets are fixed at a forward leaning angle (the recommended angle is 15 degrees from the vertical), and do not move when struck, e.g., cowboy action targets, or

gongs. The purpose of the forward leaning targets is to direct backslash, splatter and ricochet into the ground.

3.54 Steel targets should be positioned to be shot from directly in front only and not positioned where projectiles may hit the target's back, sides, mechanism, or supports. Targets should be positioned as close as practicable to the bullet catcher, backstop, side backstop, or mobile bullet catcher at the appropriate target centre height, to ensure any ricochet will be captured.

3.55 Steel targets must be free from any type of indentation or deformation that could cause unpredictable ricochet or backslash. The surface of the plate should be flat and not have any welded elements protruding from the surface (facing) of the plate. If required for fixing, round-head coach bolts (high tensile) that are near flush to the surface (facing) can be used so that splatter or ricochet are captured by the plate. All attachment points must be on the rear of the target or hidden behind support/screening materials. Any welding used in the construction of the target must not affect the Brinell Hardness of the material through excess heating. Any supporting structures for the target (e.g., a hanging steel plate), where possible, should be positioned outside of the cone of fire or be shaped to direct ricochet into the bullet catcher, backstop, side backstop, or mobile bullet catcher. If this is not possible, then any exposed target support material is to be clad with sacrificial timber or other suitable material.

3.56 Although steel targets present a hard impact surface, a ground impact surface ammunition danger area template may be applied when:

- a. Targets are positioned correctly, erected or supported at a forward leaning angle facing square on (at right angles) to the firing point.
- b. The surface behind the target within the cone of fire is not a hard impact surface.
- c. The target is located as close as possible to the bullet catcher or backstop.

3.57 Where any doubt exists, a hard impact surface ammunition danger area template is to be applied.

3.58 Grades and thickness of steel targets can be calculated based on the projectile velocity and impact energy of the ammunition used for the specific shooting activity. Abrasive resistant (AR) steel with a Brinell Hardness of no less than 450 is suitable for most uses; however, AR500 is the recommended standard.

3.59 Range standing orders may include any additional measures considered necessary by the shooting range operator to ensure the safe engagement of steel targets, including minimum safe engagement distances.

3.60 Steel plate racks may have an adjustable steel baffle angled to deflect direct impact, splatter, and ricochet towards the ground in front of the rack. There is no requirement to clad this baffle; however, any other support structures may require cladding if located within the cone of fire.

Steel target shrouds

3.61 Steel target shrouds may be used on ranges where steel targets are used to capture back splash and splatter. The provisions for the use of steel target shrouds are contained in the Pistol New Zealand Steel Target Safe Use Guide for Pistol New Zealand shooting activities. Shrouds can be constructed from any non-ricochet inducing material that is strong enough to contain back splash and splatter. Shrouds are to cover an angle of 20 degrees front to rear of the steel target. Range standing orders may include additional control measures required for the safe engagement of steel targets.

Canopy

3.62 A canopy may be installed to:

- a. **Capture pop-over** - the occasional high-angle ricochet of deformed projectiles exiting an earth or sand bullet catcher.
- b. **Contain splatter** - from targets, especially steel ones, and to prevent bullet catcher fill material and projectile fragments from leaving the range.
- c. **Protect** - the bullet catcher and target line from adverse weather conditions.

Regardless of its purpose, the canopy must span the full width and depth of the bullet catcher. If the canopy is intended to capture pop-over, it must be built to a ballistic standard using materials that are impenetrable to ricochet. For timber-framed canopies, the underside must be lined with mild steel at least 3 mm thick. This steel lining must cover at least the rear half of the canopy underside (in depth), directly above the earth or sand fill, and extend across the entire width of the canopy. The sides of the canopy must also be ricochet-resistant, and may be constructed from materials such as brick, block, mild steel, timber, or concrete (which also offer weather resistance and low maintenance). The rear half of the canopy underside is the most likely area to receive high-angle ricochets. Where applicable, the leading face of the canopy and its supporting posts must be clad with sacrificial timber to mitigate back splash.

Environmental planning considerations

3.63 When establishing a new shooting range, the shooting range operator must consult with territorial authorities and regional councils about potential environmental issues such as excessive noise levels, contaminated waste management (which may involve removal), or contamination of watercourses. Existing ranges may already be operating under existing consents and may or may not need additional territorial authority or regional council approvals. During the application process, range operators or applicants will be required to declare that all necessary territorial authority and regional council consents to operate the pistol shooting range, or non-pistol shooting range, have been obtained.

3.64 Environmental issues may include:

- a. **Lead contamination** - into the ground, ground water, waterways, buildings, and surrounding areas.
- b. **Extraction of airborne contaminants (indoor ranges)** - the ventilation system should be filtered before the airflow expels into the external environment.
- c. **Noise containment and suppression** - potentially excessive internal and external noise levels.
- d. **Risk of fire** - due to excessive build-up of unburnt powder e.g., initiated by muzzle flash.

3.65 Health issues associated with indoor and outdoor shooting ranges may include:

- a. Exposure to lead.
- b. Harm from airborne contaminants produced during firing.
- c. Damage to hearing.
- d. Damage to eyesight.

Landowner consent

3.66 A shooting range operator must obtain the consent of all landowners whose property is to be used for the operation of their shooting range and its associated danger area.

Air danger height and airspace restrictions

3.67 Air danger height (ADH) is the maximum height above ground level at which a hazard to aircraft may exist. The air danger height is either the highest point of an aimed shot or the maximum ricochet height of the ammunition fired.

3.68 Air danger height has two implications for the design and operation of a shooting range, and must be considered for:

- a. **Civil aviation authority** – The range operator must notify the Civil Aviation Authority in advance if the trajectory of a projectile is likely to exceed:
 1. 45 metres (150 feet) above ground level within 4 km of an aerodrome boundary, or
 2. 120 metres (400 feet) above ground level if more than 4 km from an aerodrome boundary.
- b. **Ammunition ricochet danger height:**

Ricocheting projectiles can fly to a height where they become a hazard to aircraft. Ricochet is considered in the design, construction, and operation of shooting ranges e.g., the use of baffles. The potential for ammunition ricochet danger height must be considered for reduced danger area and full danger area ranges. It is not a requirement for no danger area ranges.

3.69 Where a shooting range is located within 4 km of an aerodrome, it is a legal requirement for the shooting range operator to liaise with the aerodrome operator to identify any procedures required for the safe operation of both facilities. This may require a formal agreement to be established between the shooting range operator and the aerodrome management.

3.70 Where a shooting range is located more than 4 km from an aerodrome boundary and has an air danger

height above 120 metres (400ft), the SRO must notify the Civil Aviation Authority.

Airspace intrusion

3.71 It is difficult to accurately judge the height of low flying aircraft within the danger area of a shooting range. Therefore, any airspace intrusion is to be controlled safely by the Officer on Duty stopping all shooting for the duration of the intrusion. This is to be clearly stated in range standing orders.

Indoor non-pistol shooting range design and construction

3.72 Indoor non-pistol ranges have specific criteria for the safe design and construction of these ranges. It is recommended that the SRO seeks advice from Clubs and Ranges.

Clay target (shotgun) shooting range design and construction

3.73 Clay target shooting ranges have various criteria for the safe design and construction of shotgun shooting ranges, depending on the specific shooting activity. It is recommended that the SRO seeks advice from Clubs and Ranges.

Measuring a shooting range

3.74 A video explaining how to measure specific components and structural features of a shooting range is available on the [Clubs and Ranges webpage of Te Tari Pūreke – Firearms Safety Authority](#) website (see figure 3.5).

Figure 3.5 – Video explaining how to measure components of a shooting range



Section

4

Bullet Catcher

Range Floor

Firing Bench



Section 4

Shooting range danger areas, signage, and flags



Shooting range danger area definition

- 4.1 The shooting range danger area is the space where there may be a risk of injury to people or damage to property from a correctly aimed shot.
- 4.2 A shooting range danger area is not designed to contain a shot deliberately or accidentally fired in breach of range discipline or range standing orders.

Shooting range danger area

- 4.3 This section contains dimensions and examples of ammunition danger area templates. The range danger area design is dependent on the ballistic characteristics of the type of firearm and ammunition to be used, range construction (site and design), the approved shooting activities, and the range design cone of fire. It also depends on the safe management of these shooting activities by the Officer on Duty and compliance with range standing orders. The size and shape of the range danger area(s) is obtained by the application of an ammunition danger area template.

Types of shooting range danger areas

- 4.4 There are three types of range danger areas that may be applied to a shooting range (see figure 4.1). These are:
 - a. No danger area (NDA).
 - b. Full danger area (FDA).
 - c. Reduced danger area (RDA).

No danger area

- 4.5 A NDA range is one where the range is designed to capture all direct shot, ricochet, backsplash or splatter within the active range area. Factors that must be considered in order to establish a no danger area range include:
 - a. Minimum acceptable dimensions of the bullet catcher/backstop including the correct slope.
 - b. Maximum firing distance.
 - c. Type of firearm and calibre.
 - d. Cone of fire to be applied.
 - e. Type of shooting activity.
 - f. Type of target to be engaged.
 - g. Type of shooting posture to be adopted.
 - h. Where high-velocity ammunition is used, a canopy should be considered.
 - i. An air danger height is not required for a no danger area range; however, it is considered good practice to stop firing whilst an aircraft is flying over the range.



The shooting range danger area is the space where there may be a potential risk of injury to people or damage to property from a correctly aimed shot fired from a firearm on a shooting range.



The range danger area design is dependent on the ballistic characteristics of the type of firearm and ammunition to be used, range construction (site and design), the shooting activities approved for use, and the range design cone of fire.

Figure 4.1 – Shooting range danger area decision flowchart

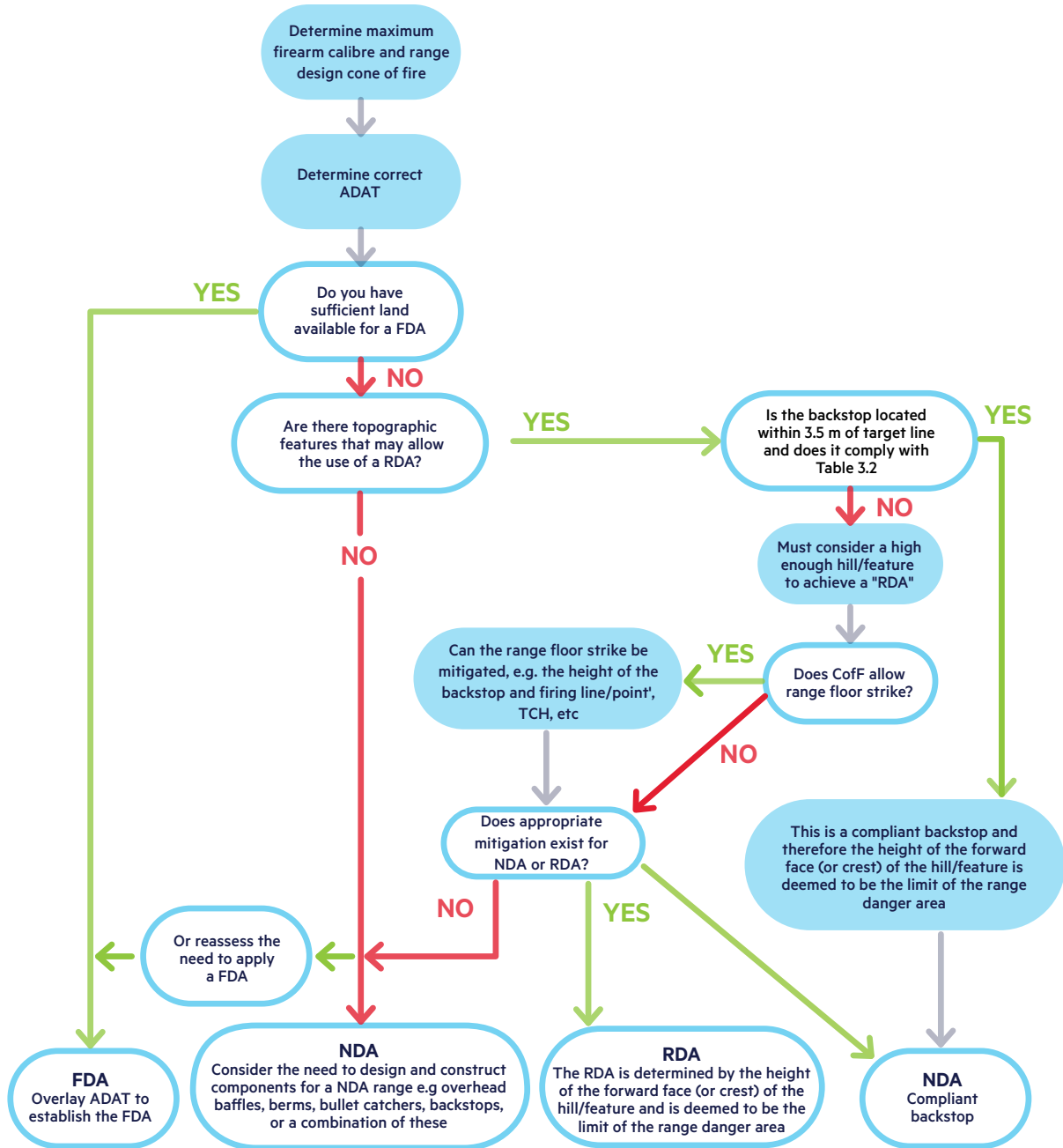

4.6 If projectiles land in any place outside of the range danger area the Officer on Duty must immediately cease shooting activities on the range and investigate the cause. If any deficiencies in range design or construction are identified, the shooting range operator must contact Clubs and Ranges for advice.

Full danger area

4.7 A FDA range is an outdoor range where the maximum distance of the danger area is limited only by the quadrant elevation of the firearm, the skill of the shooter and use of the correct ammunition danger area template (refer to table 4.2).

Range design cone of fire is not captured by an artificial structure or topographic feature

4.8 On outdoor shooting ranges where the range design cone of fire is not captured by an artificial structure or topographic feature, a full danger area range must be established.

Reduced danger area

4.9 A RDA must only be considered when a NDA or FDA cannot be achieved. A RDA may be applied to an outdoor range by using a significant topographic feature which is high, steep and wide to capture all predicted direct shot and ricochets. When the appropriate ammunition danger area template is applied, identify the prescribed contour line within the left and right of arc, to establish the reduced danger area cut-off. The designated cut-off must be contained completely within the approved land boundary for the total width of the template (see figures 4.2, 4.3 and 4.4). The following criteria (or combination of) must be considered to establish a reduced danger area range:

- a. The ADAT for the largest calibre to be used on the range.

- b. Targets - locations, elevation (altitude) and type (e.g., steel) are required. The range axis can be identified once the target locations are confirmed.
- c. Firing line(s)/point(s) locations. The range axis can be identified once firing lines are confirmed.
- d. Slope angles - The slope of the topographic feature determines the minimum height at which the reduced danger area cut-off can be applied:
 1. A slope of 56 degrees or greater is not expected to have surfaces that will cause ricochet. A steeper slope will intersect escaping bullet trajectories sooner in their upward flight. Therefore the reduced danger area cut-off point or designated contour line can be a minimum height in elevation of 50 metres above the highest target location.
 2. A slope of 30 degrees up to 56 degrees may cause a ricochet and therefore the reduced danger area cut-off point, or designated contour line, can be a minimum height in elevation of 100 metres above the highest target location.
 3. When the reduced danger area cut-off has been determined at 50 metres or 100 metres in elevation from the highest target, the elevation of the target and cut-off are to be recorded in the supporting information for the template.
- e. RDA is not to be applied to a slope that is less than 30 degrees. Any variation from the above RDA criteria may be considered subject to review and approval by Police.

Pop-over

4.10 Pop-over is where there is a tendency for the occasional high velocity projectile to deform and ricochet at high angle out of an earth or sand bullet catcher. On ranges where pop-over is considered a risk, and a canopy does not exist, RSOs are to have a procedure for dealing with pop-over should it occur, e.g., the Officer on Duty is to stop the activity immediately until a safe solution is implemented. If a solution cannot be identified, the shooting activity must be removed as an approved activity on the range.

Figure 4.2 – CofF captured by a topographic feature with a slope of 56 degrees or greater

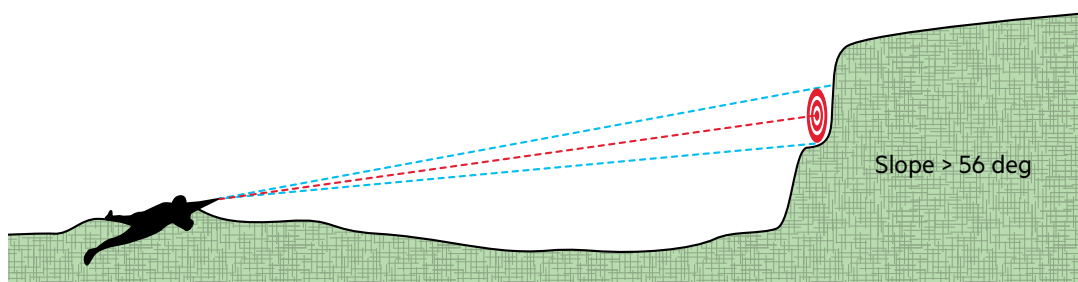
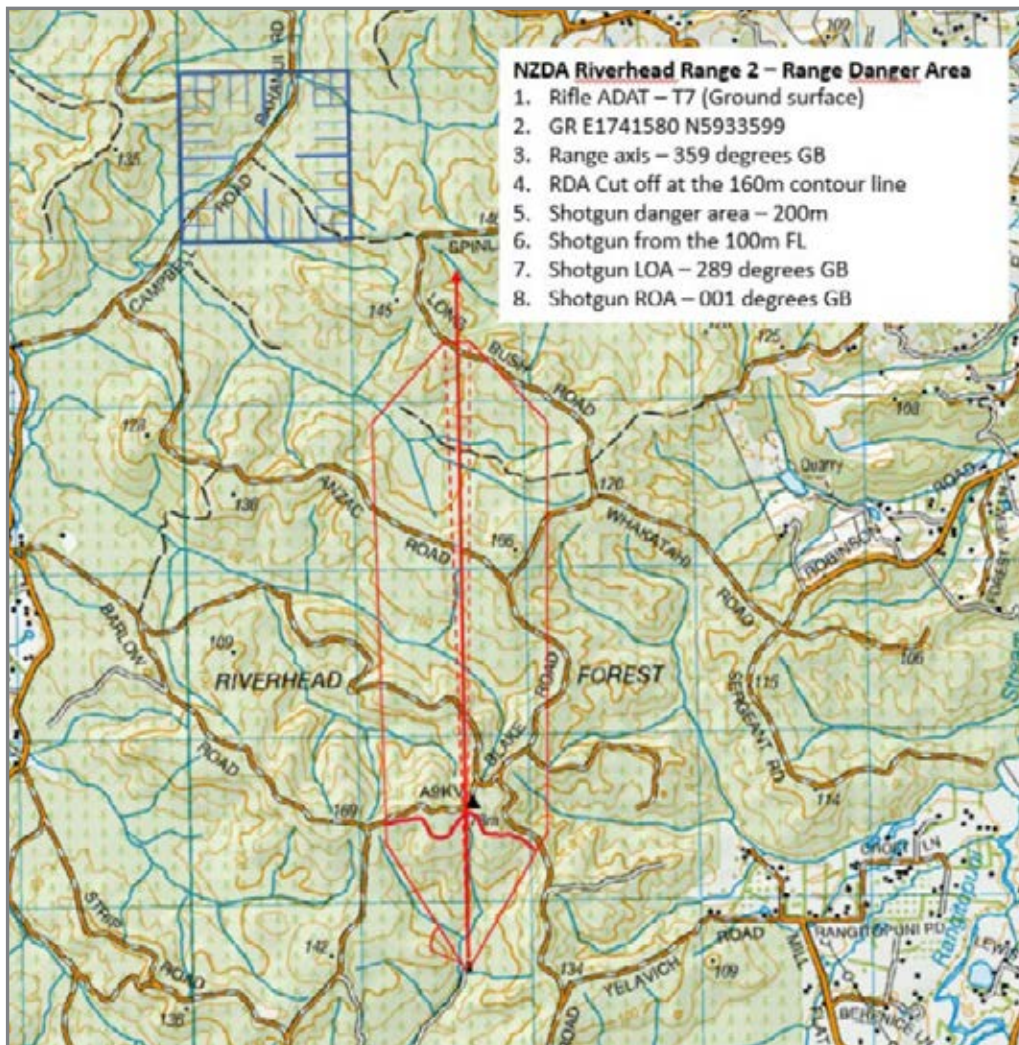

Figure 4.3 – Coff captured by a topographic feature



Figure 4.4 – Electronic application of an ADAT to produce a scale diagram of the range danger area with the reduced danger area indicated by the red bold line using the Microsoft PowerPoint software application



Effect of trees in shooting range danger areas

- 4.11 Tree cover in a range danger area or on top of a backstop may be desirable for an outdoor range for aesthetics or noise reduction; however, trees do not allow a reduction in size of a range danger area or increase the height of a backstop.

Activity inside a shooting range danger area - managing the risk

- 4.12 The Officer on Duty must stop all firing immediately if people enter the shooting range danger area.
- 4.13 The range perimeter danger signs serve to warn people in the area, e.g., hunters, farm workers and contractors, who could unknowingly enter the range danger area.

Determining a shooting range danger area

- 4.14 The range danger area is determined by applying the correct ammunition danger area template

(1:50,000 scale or 1:25,000 scale) from the firing point/line along the range axis (direction of fire) on a topographic map (1:50,000 scale or 1:25,000 scale) of the range location. The outline of the ammunition danger area template is traced onto the map. This procedure will produce a range danger area for the approved ammunition type, at a given cone of fire, with a restricted quadrant elevation, over a single arc of fire. See table 4.1 for an overview of the steps required to determine a range danger area and figure 4.5 for a process flowchart.

Impact surfaces

- 4.15 Impact surfaces are all surfaces within the range design cone of fire that are able to be struck. Impact surfaces are categorized as:
- a. **Hard impact surfaces** which include concrete, rock, steel, and frozen surfaces.
 - b. **Ground impact surfaces** are surfaces other than hard impact surfaces. The composition and depth of the ground (including topsoil and vegetation) in some regions may allow for the ricochet angle to be reduced if it is considered safe to do so by Clubs and Ranges.

Figure 4.5 – Process flowchart
Determining a shooting range danger area

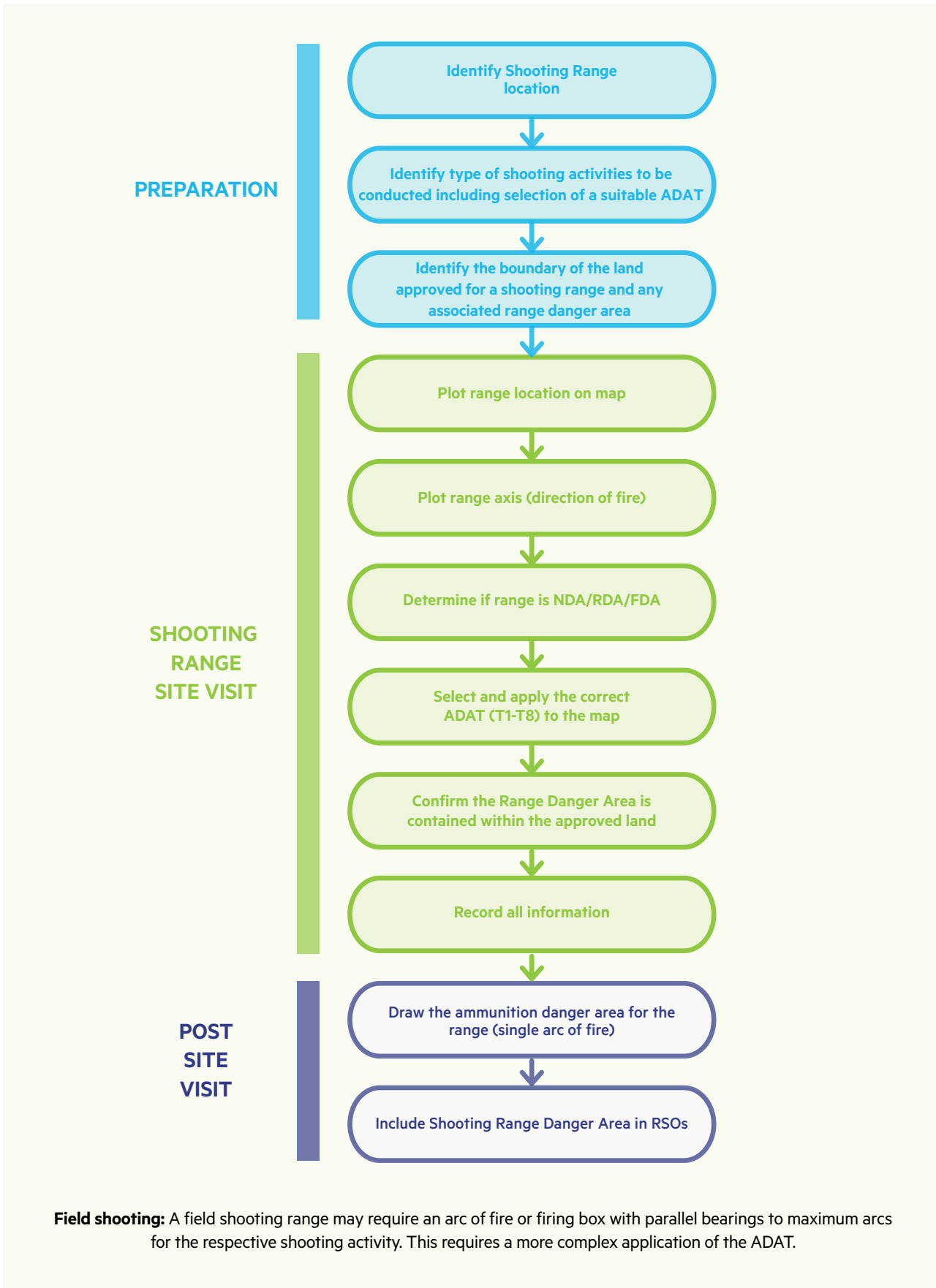

Table 4.1 – Steps required to determine a shooting range danger area

STEP	ACTION	DETAILS
PREPARATION		
1	Identify the range location	- Obtain a 1:50,000 or 1:25,000 scale topographic map of the overall range location
2	Identify type of shooting activity to be conducted on the range	- Obtain the correct ADAT required for the templating (the scale of the ADAT must match the scale of the map)
3	Identify the boundary of the land approved for use as a shooting range	- Plot the boundary on the map
ONSITE		
4	Plot the individual range location on the map	- Walk the ground and familiarise yourself with the range layout and features - Move to the furthest firing point/line on the range, position yourself in the centre facing the direction of fire, and plot your location on the map as a NZTM grid reference (GR)
5	Plot the range axis (direction of fire)	- Ensure that you are positioned at the same GR in Step 4 - Single Line of Fire: If using a Firing Point (FP), measure the range axis through the centre of the target line from the FP. This bearing should be at right angles to the target line (this will be a Magnetic Bearing (MB) if using a compass) - Convert the MB to a Grid Bearing (GB) and plot the centre of arc (range axis) on the map. Take the appropriate ADAT for the ammunition to be used (use largest calibre) and the type of surface (ground or hard), place the ADAT on the FP and align with the centre of arc (range axis) - Visualise the range danger area to see if it fits within the land approved for the shooting activity - Arc of Fire: If using a Firing Line (FL), measure range axis from the centre of the FL to the centre of the target line (this will be a MB if using a compass) - Move to the furthest left firing position on the FL and measure the left of arc (to furthest left target). Move to the furthest right firing position on the FL and measure the right of arc (to furthest right target) - Convert the MBs to GBs and plot them on the map, select the appropriate ADAT for the ammunition to be used (use largest calibre) and the type of surface (ground or hard). Place the ADAT on the left end of the FL, align the spine of the ADAT with the left of arc, and then move the ADAT to the right end of the FL, and sweep the spine of the ADAT to the right of arc - Arc Markers: Fixed or temporary arc of fire markers can be used to establish a maximum left or right of arc instead of using the extreme flank targets. They can be an easily identified point on a natural topographic feature (i.e. a spot height), or a man-made marker(s) which can be fixed or temporary - Visualise the range danger area to see if it fits within the land approved for the shooting activity
6	Select the correct ADAT – (from T1 to T8)	- Based on largest calibre to be fired - Approved CofF - Maximum quadrant elevation (QE) - Consider if a hard impact surface is to be engaged - Consider the air danger height (ADH)
7	Manually apply the selected ADAT to the map	- Place the ADAT FP on the map GR and align the centre spine of the ADAT with the direction of fire GB plotted on the map - If firing is to take place closer to the target line, the firing point on the ADAT is to be moved to the closest engagement distance and the range danger area re-assessed
8	Determine if the range is an NDA, FDA, RDA, Range	- Identify any man-made or natural feature that could be used to safely reduce the danger area for the shooting activity - To achieve RDA or NDA status, the approved CofF of the ADAT must be contained by the selected man-made or natural feature - A NDA Range does not require a scale diagram of the range danger area, but does require a GB for the range axis (direction of fire)
9	Confirm range danger area	- Confirm that the range danger area is contained within the approved land boundary for the shooting activity
10	Record all information (onsite)	- GR to the maximum/minimum firing point/line - GB for the range axis (direction of fire) - GR to selected backstop/natural feature/limit of RDA
POST SITE VISIT		
11	Draw the scale diagram of the range danger area (single arc of fire)	- Draw the full ammunition danger area onto the map applying the correct ADAT - Check and confirm the accuracy of all GRs and the GB - Check and confirm the accuracy of the scale drawing - Annotate the scale drawing with the key information including but not limited to the FP, axis, left and right of arc
12	Include in RSOs	- Prepare the scale drawing of the range danger area for inclusion in RSOs
Note	Field Shooting Range – Danger Area	- A field shooting range may require a firing box and an arc of fire for the respective shooting activity. This requires a more complex application of the ADAT. It may also require the application of a firing box using parallel arcs

Selection and application of an ammunition danger area template

4.16 The ammunition danger area template must be relevant to the types of firearms and ammunition to be used on the range and must accommodate all types of shooting activities to be conducted on the range. This section includes guidance on the design, construction and application of an ammunition danger area template including examples of various templates. Scale diagrams of templates T1 to T8 (drawn to 1:25,000 scale) are available in figures 4.7 - 4.9 and can be obtained at [Clubs and Ranges webpage of Te Tari Pūreke – Firearms Safety Authority](#) Alternatively, the ammunition danger area template for a specific shooting discipline can be obtained on request to the relevant national shooting organisation.

Ammunition danger area template design explanation (see figure 4.6)

1. **Line A – B.** Line A – B is a straight line between the firearm and the target, which has been extended to reach the maximum length of the ammunition danger area template. The maximum length of the ammunition danger area template is either:
 - a. the maximum possible range of the projectile, or
 - b. the maximum possible range of the projectile based on the quadrant elevation.
2. **Line A – C.** Line A – C is the cone of fire angle applied to Line A – B. The angle between Line A – B and Line A - C will vary depending on the cone of fire applied.
3. **Line A – D.** Line A – D is the opening ricochet angle and, unless empirical data exists to the contrary, it is always to be at an angle of 30 deg (530 mils) to Line A – C.
4. **Line C – E.** Line C – E is the closing ricochet angle and, unless empirical data exists to the contrary, it is always to be at an angle of 45 deg (800mils) to Line A – C.
5. **Line E – D.** Line E – D is the ricochet boundary. Ricochet distance between line A – C and E - D is recommended to be one eighth of the maximum distance A - B for ground surfaces (see Note 3) or one quarter for hard surfaces (see Note 2).

Notes:

1. Completion of the Ammunition Danger Area Template. Lines A – C, B – C, A – D, C – E and D – E are mirrored to the right of Line A – B to complete the ammunition danger area template.
2. **Hard impact surfaces** which include concrete, rock, steel, and frozen surfaces.
3. **Ground impact surfaces** are surfaces other than hard impact surfaces. The composition and depth of the ground (including topsoil and vegetation) in some regions may allow for the ricochet angle to be reduced if it is considered safe to do so by Clubs and Ranges.
4. Engagement of steel targets. When approved steel targets are used, the hard impact surface template may be replaced with application of the ground impact surface template. For this to be approved the following criteria must be met:
 - a. The grade of the steel used for the target must be appropriate to withstand the impact of the maximum calibre of ammunition approved in RSOs. The grade of steel can range from AR450 for low velocity up to AR500 (or higher) for high velocity ammunition. For long range rifle shooting the grade of steel may be reduced to AR450 (or less) where the firing distance exceeds 700 metres. The grade of steel for airgun pellets is appropriate to withstand the direct impact of air pellets and strong enough to remain undamaged.
 - b. Steel targets must be presented centrally in a near vertical or forward leaning angle (from the vertical) of at least 15 degrees (or at a suitable angle to direct projectiles and splatter towards the ground) and be placed as close as possible to the toe of the bullet catcher or backstop at an appropriate target centre height to mitigate potential for range floor strike to occur.
 - c. Steel targets must be positioned at a right angle (perpendicular) to the line of fire from their corresponding firing point.
 - d. Steel targets must be regularly inspected for damage or pitting and refurbished or replaced as required.
 - e. Pistol shooting (including rifles firing pistol calibres and shotguns firing 'lead shot') at steel targets does not create as great a risk as does high velocity ammunition. The Pistol New Zealand Steel Target Safe Use Guide for pistol shooting provides very comprehensive information for shooting at steel targets in all pistol shooting disciplines.
 - f. An SRO is advised to seek advice from Clubs and Ranges or their association when planning to establish a new range or upgrade an existing one that will need the application of an ammunition danger area template, for shooting at steel targets with high velocity ammunition.

NB: When shooting at steel targets the 'ground surface ammunition danger area' may be utilised by the careful placement of steel targets to ensure any ricochet off the edge of the target will be captured by the bullet catcher or backstop. If there is any doubt, the 'hard surface ammunition danger area template' must be applied.

Figure 4.6 – Example of the components of an ammunition danger area template

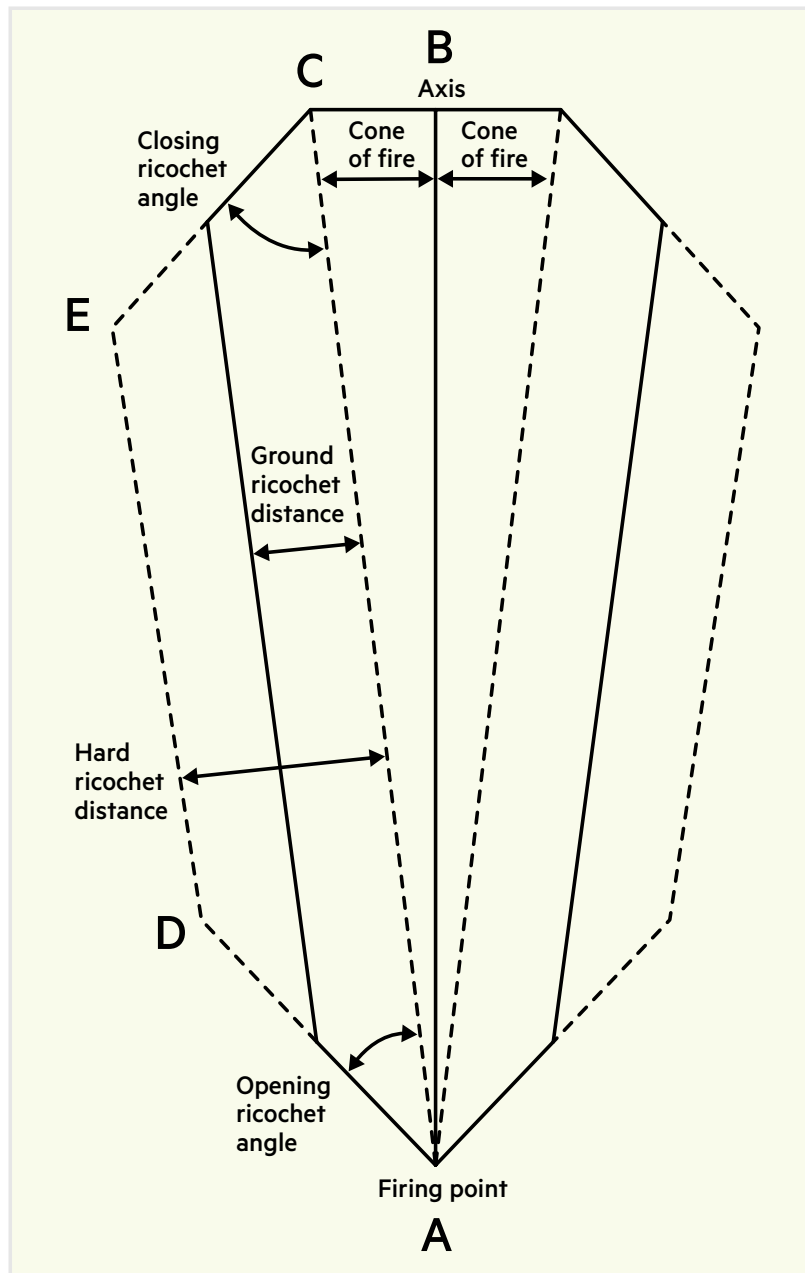

Note 1: Scale diagrams of all ammunition danger area templates can be found at [Te Tari Pūreke – Firearms Safety Authority website](#). These diagrams can be printed to scale and photocopied onto an A4 transparent plastic film (also known as foils or transparencies).

Note 2: T1 to T8 ADATs are drawn with a quadrant elevation of 150 mils. The cone of fire for rifle is 20 mils (1.125 deg) and for pistol is 23 mils (1.29 deg).

Table 4.2 – Ammunition danger area template (ADAT) dimensions

ADATs can be produced by deterministic or probabilistic safety analysis methods recognised by Police. Table 4.2 shows deterministic ADATs dimensions by firearm type.

Template	Cone of Fire	Suitable Firearms	Maximum Distance (m)	Opening Ricochet Angle (mils/deg)	Ricochet Distance (Ground) (m)	Ricochet Distance (Hard) (m)	Ricochet Closing Angle (mils/deg)	Air Danger Height (ft/m) AGL	Backsplash Safety Distance Ground /Hard (m) (See note 6)
T1	10 mils	22LR Rimfire rifle	1400	270 mils (15°)	175	350	800 mils/45°	500 ft/150 m	10 Ground 22 Hard (for T1/T1a/T2/T3)
T1a	23 mils	Rimfire pistols	1400	270 mils (15°)	175	350	800 mils/45°	500 ft/150 m	
T2	23 mils	Centrefire Pistol up to .50 cal	2000	270 mils (15°)	250	500	800 mils/45°	500 ft/150 m	
T3	20 mils	Muzzle loading and percussion rifles	2000	270 mils (15°)	250	500	800 mils/45°	500 ft/150 m	
T4	20 mils	Centrefire Rifles up to .223 inch/5.56 mm (See Note 1)	2000	530 mils (30°)	250	500	800 mils/45°	500 ft/150 m	22 Ground 50 Hard (for T4/T5)
T5	20 mils	Centrefire Rifles up to .223 inch/5.56 mm (See Note 2)	2500	530 mils (30°)	320	640	800 mils/45°	500 ft/150 m	
T6	20 mils	Centrefire Rifles up to 8mm (.308 inch/7.62 mm) (See Note 3)	2900	530 mils (30°)	400	800	800 mils/45°	500 ft/ 150 m	22 Ground 50 Hard
T7	20 mils	Centrefire rifle .338 inch	3700	530 mils (30°)	450	900	800 mils/45°	500 ft/150 m	100 Ground 300 Hard
T8	20 mils	Centrefire Rifle .50 inch	5200	530 mils (30°)	650	1300	800 mils/45°	3000 ft/ 1000 m	120 Ground 350 Hard
Shotgun		(See Note 4)	200						
Black powder heavy armaments		Black powder cannons and mortars (See Note 5)							

Notes:

1. T4 is to be used for firearms groups that fit within .223 inch/5.56 mm firing ammunition up to 55 grains.
2. T5 is to be used for firearms groups that fit within .223 inch/5.56 mm firing ammunition > 55 grains up to 69 grains.
3. T6 is to be used for firearms groups that fit within the .308 inch/7.62 mm (up to 8 mm) firing ammunition >69 grains. Other calibers can be used as long as they remain within the approved muzzle energy.
4. Shotgun using shot or slug:
 - a. Shot - A shotgun ADAT is determined by the 'shot-spread' (created by the approved gauge and shot size) combined with the arc of fire (AofF) applied when engaging aerial (clay) targets on a set flight path. The arcs of fire may be designated by ground markers or the use of shooting stands/stalls/stations which limit the shooters left and right of arc.
 - b. Slug - When using slug the T3 ADAT is to be used with a 680 metres maximum distance.
5. Black powder cannons and mortars - There are no specific template dimensions for black powder cannons and mortars. The shooting range operator must be satisfied that firing of these firearms will not breach the approved range danger area. When calculating the danger area for black powder cannons or mortars, the following criteria must be considered:
 - a. The direction of fire and maximum distance of the range danger area.
 - b. The type and weight of the projectile.
 - c. The amount of powder to be used.
 - d. The angle of fire or elevation setting.
6. Shooting can occur within the backsplash safety distance (providing personal protective clothing and equipment is worn), in accordance with the minimum safe engagement distances stated in range standing orders.

Figure 4.7 – 1:25,000 T1 - T1a - T2 - T3 - T4 Templates

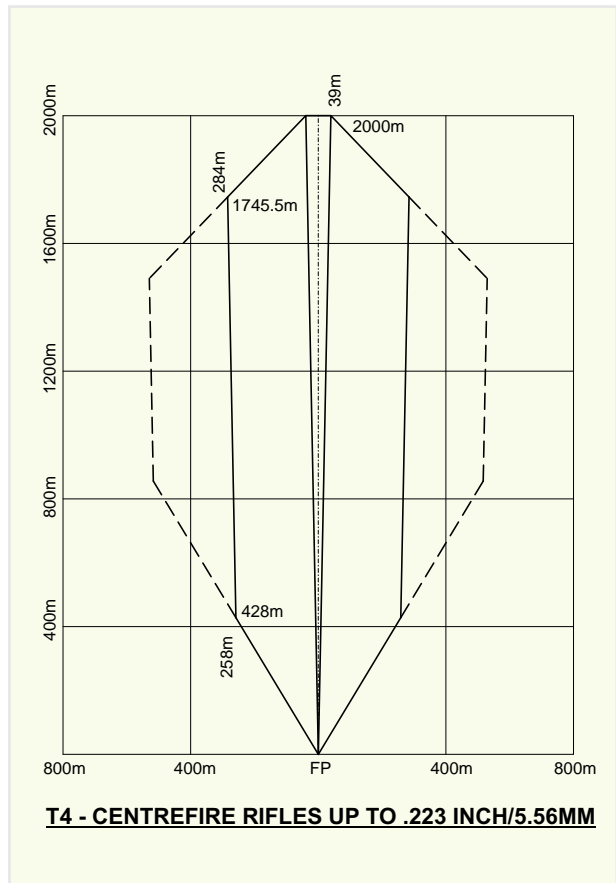
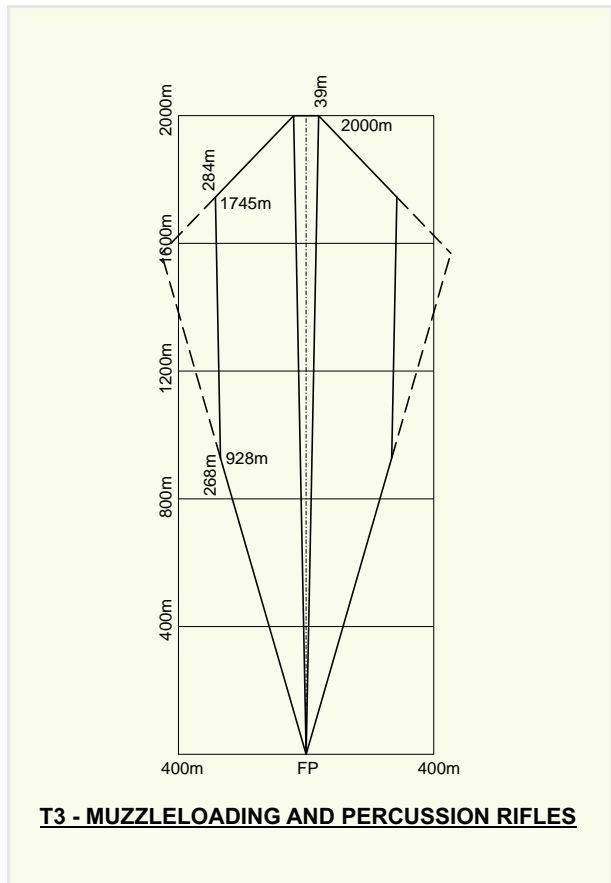
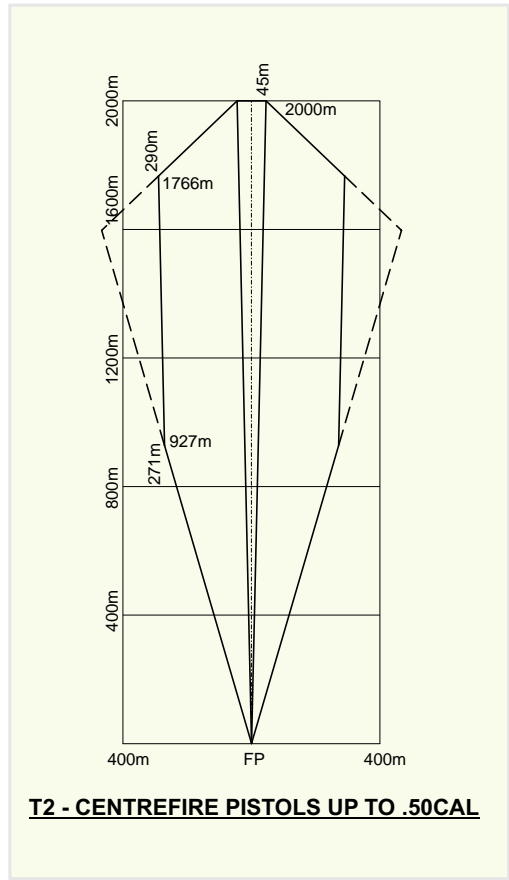
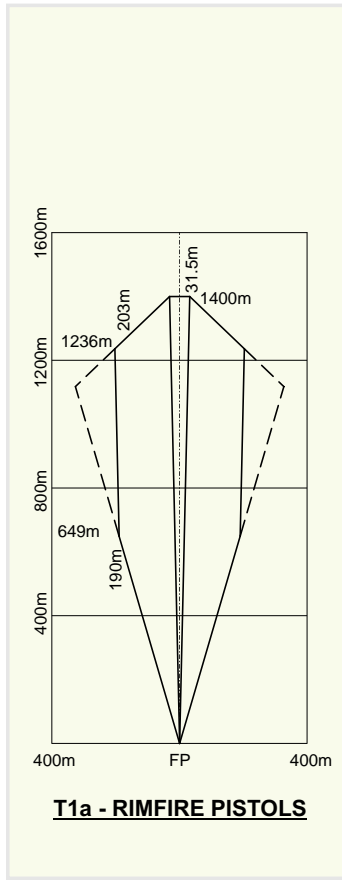
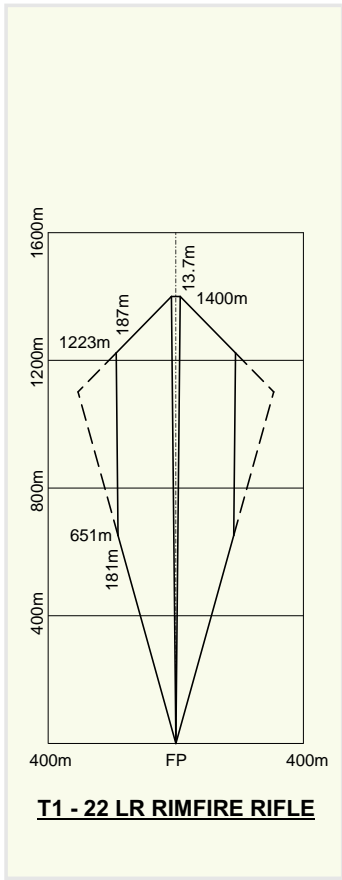
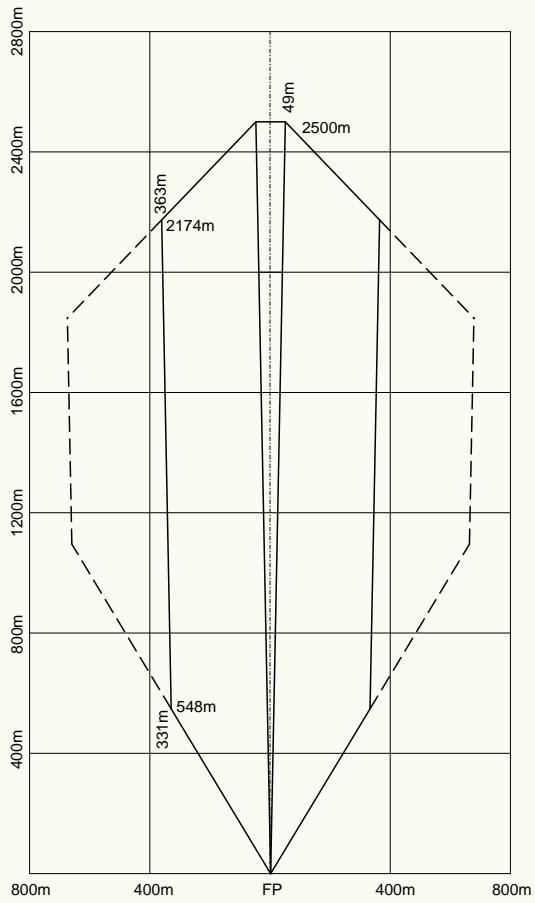
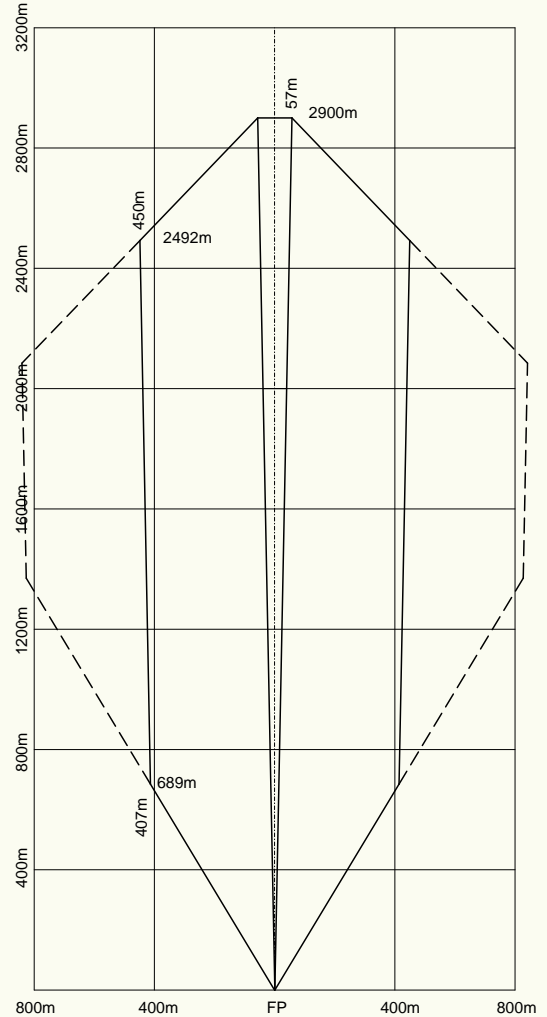

Figure 4.8 – 1:25,000 T5 - T6 Templates



T5 - CENTREFIRE RIFLES UP TO .223 INCH/5.56MM



T6 - CENTREFIRE RIFLES .308 INCH/7.62MM UP TO 8MM

Figure 4.9 – 1:25,000 T7 - T8 Templates

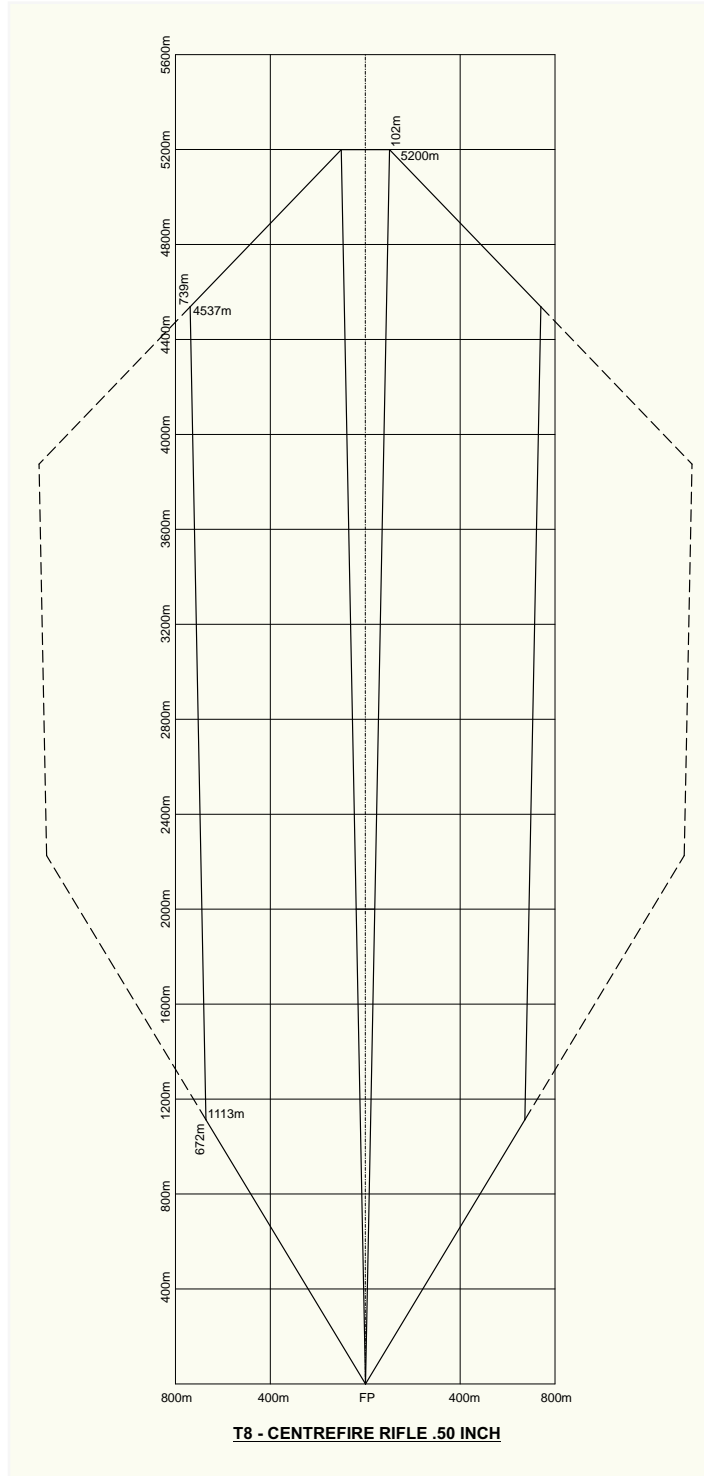
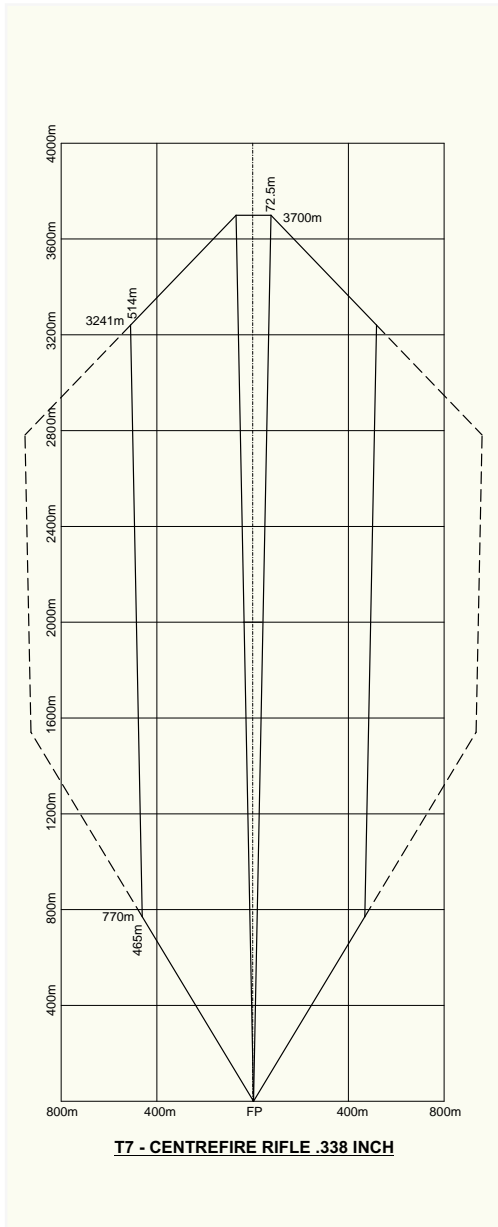
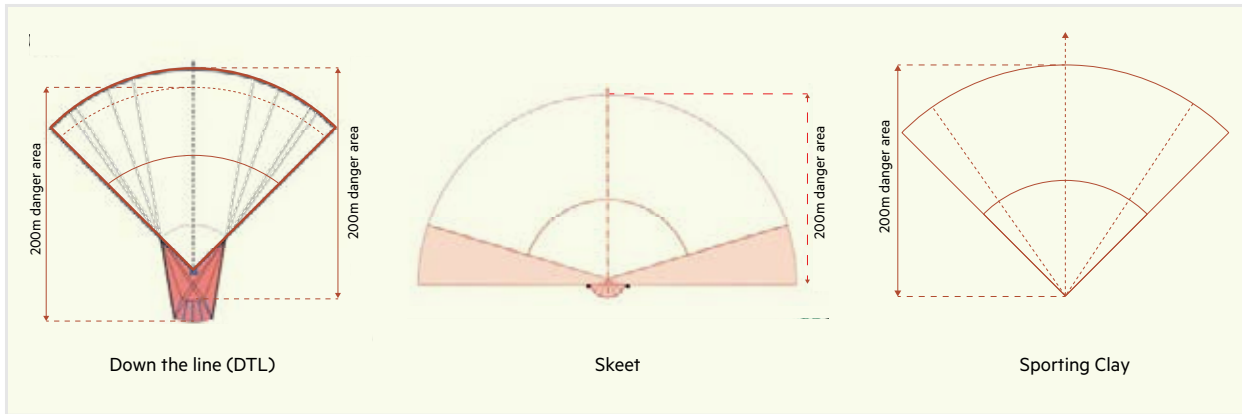

Figure 4.10 – Examples of shotgun ammunition danger area templates (not to scale)



Note 1: Where steel shot is used, the range danger area is reduced to 150 metres.

4.17 Application of an ammunition danger area template (see figures 4.7 to 4.15)

1. The application of an ammunition danger area template requires a skill level which can be achieved through training and practice. The purpose of applying a template is to produce a scale diagram on a topographic map of the shooting range danger area. This diagram is included in the shooting range standing orders. Police have provided videos on how to apply an ammunition danger area template at the Clubs and Ranges webpage at [Clubs and Ranges webpage of Te Tari Pūreke – Firearms Safety Authority](#).
2. **Types of danger area applications.** There are three main types of application that are explained in the training videos, they are:
 - a. **Application 1** - A firing point with a single line of fire (the range axis/direction of fire)
 - b. **Application 2** - A firing line with a left and right of arc
 - c. **Application 3** - A firing box with a left and right of arc (applying the parallel bearings technique).
3. There are other types of danger areas that can be applied for specific shooting activities where the application of the template is more complex. Clubs and Ranges can provide advice for these situations.
4. **Range site survey.** Before applying a template to the map, the SRO requires information which must be gathered during a range site survey (sometimes referred to as a ground reconnaissance). The following information is required and must be recorded accurately:
 - a. The grid reference(s) of the firing point/line/box
 - b. A grid bearing for the direction of fire (range axis)
 - c. A grid bearing for the left and right of arc (where applicable)
 - d. **Arc Markers.** Fixed or temporary arc of fire markers can be used to establish a maximum left and right of arc instead of using the extreme flank targets. They can be an easily identified point on a natural topographic feature (i.e. a spot height) or man-made markers which can be permanent or temporary.
 - e. The boundary of the land approved for the use as a shooting range (only the section of the boundary relevant to the shooting range location if a large property).
5. **Reduced danger area backstops.** The grid reference of the feature to be used as the backstop to reduce the danger area including any relevant information, e.g., the contour line of the cut-off point, and description of the feature(s).

Note: It is necessary to take the relevant template on the survey so that it can be applied for map to ground orientation of the planned range danger area.
6. **No danger area ranges.** Although there is no requirement to apply a template for a no danger area range, a template can be overlaid for the purpose of risk management to assess the impact of a failed range feature which may cause the no danger area criteria to be compromised.

Figure 4.11
Example of a firing line with a left and right of arc

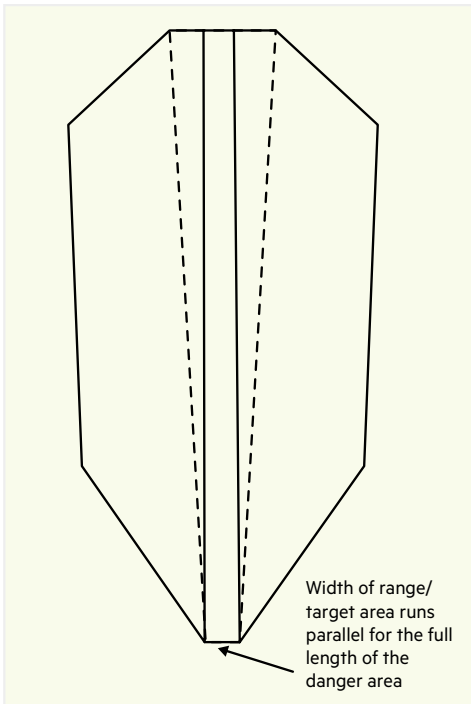

Figure 4.12
Example of template design for field shooting

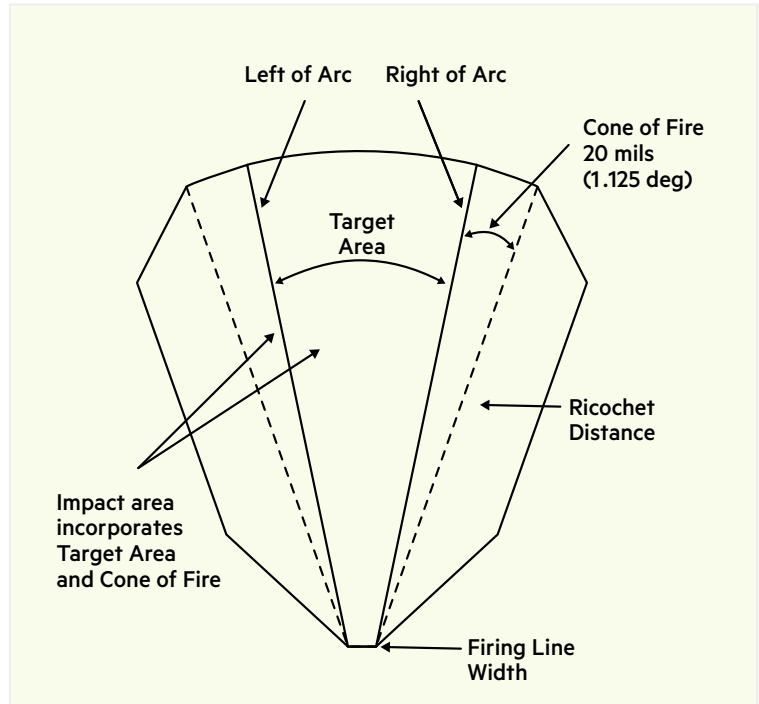

Figure 4.13
Example application of an ammunition danger area template from a firing box using parallel bearings with a maximum left and right of arc applied

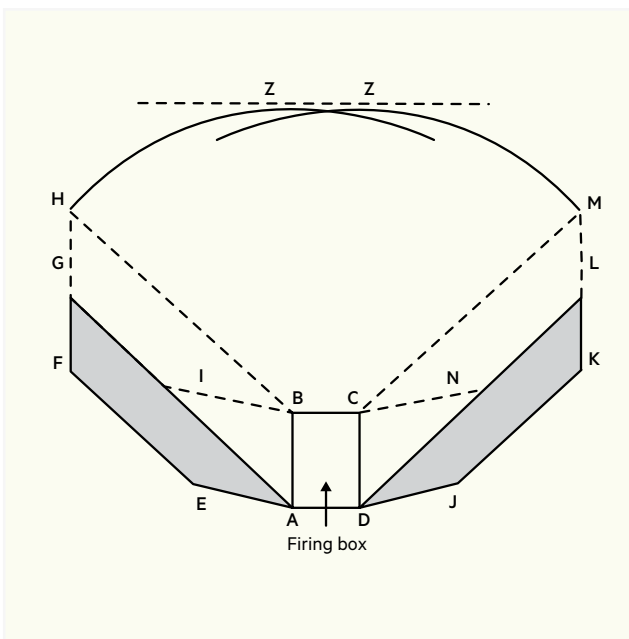
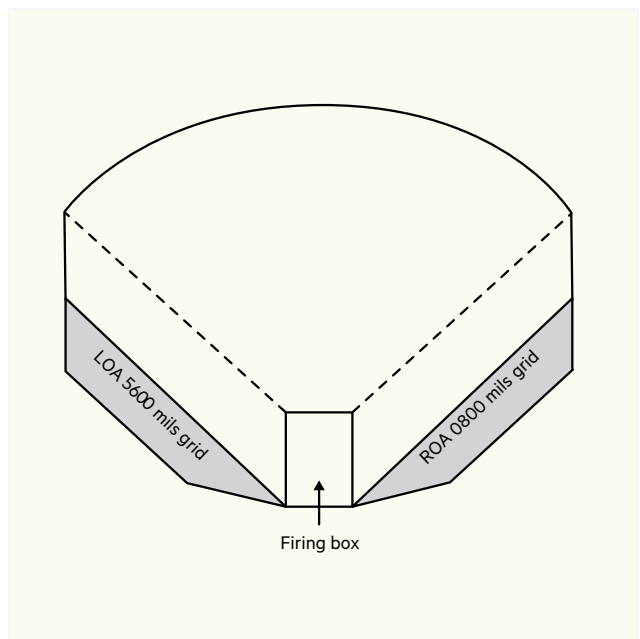
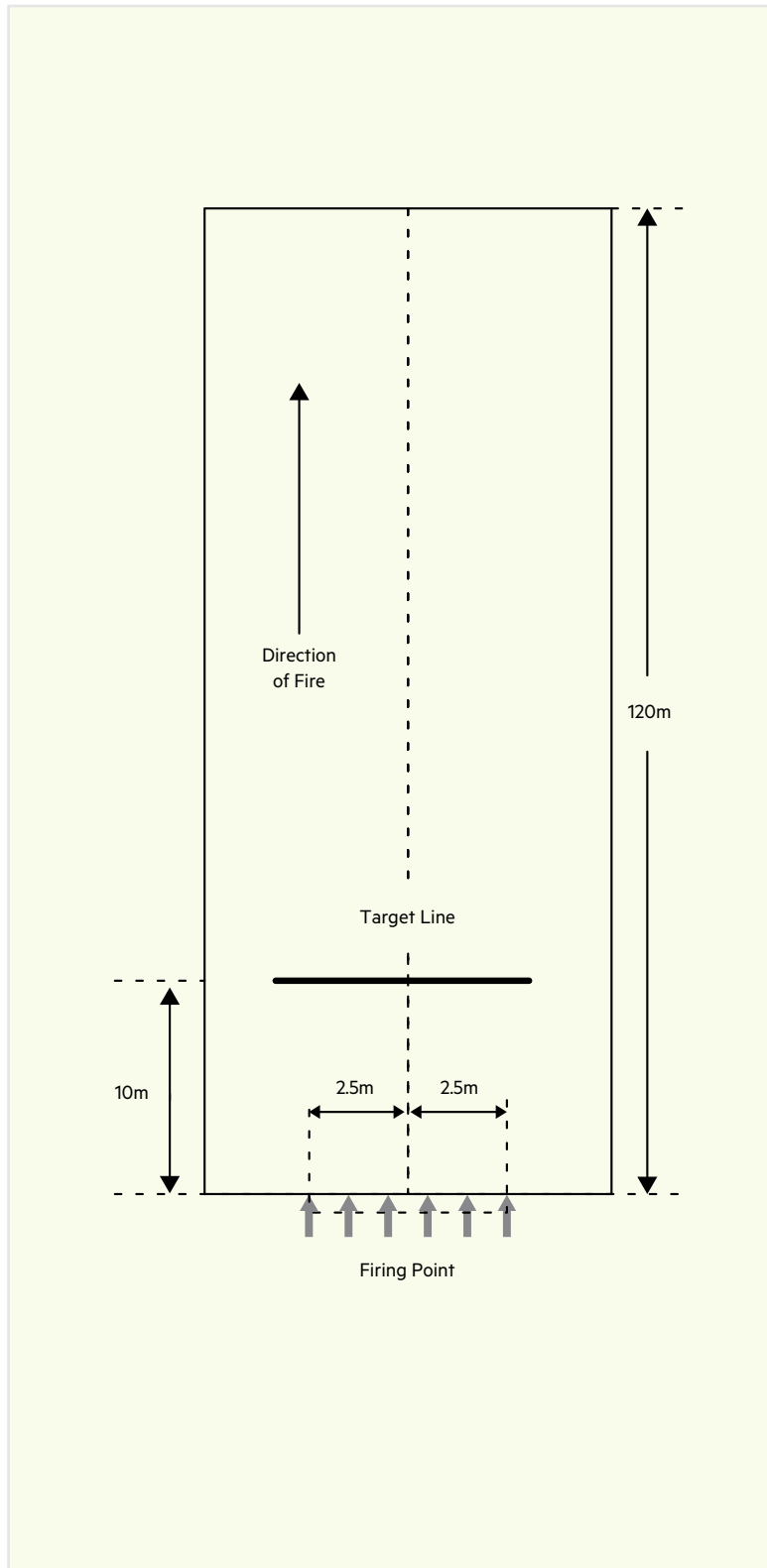

Figure 4.14
Example of a completed firing box using parallel bearings with maximum left and right of arcs



Note: Videos explaining the application of an ammunition danger area template can be found at the Clubs and Ranges webpage at [Te Tari Pūreke – Firearms Safety Authority website](http://www.firearms.govt.nz)

Figure 4.15 – Air rifle 0.177 (up to 12ft lbs) outdoor full danger area template (not to scale)



Technical guidance for shooting range certification and enrolment

4.18 The following resources are available to view and/or download from the Clubs and Ranges webpage, [Clubs and Ranges webpage of Te Tari Pūreke – Firearms Safety Authority](#):

- a. **Shooting range danger area electronic templating** – There are four power point presentations on the website that explain and demonstrate methods that can be used to determine a shooting range danger area by application of an electronic ammunition danger area template (ADAT):
 1. **Method 1 - ADAT Template Electronic Application 1** - Firing point with a single line of fire.
 2. **Method 2 - ADAT Template Electronic Application 2** - Firing line with a left of arc and right of arc.
 3. **Method 3 - ADAT Template Electronic Application 3** - Firing box with a left of arc and right of arc.
 4. **Method 4 - ADAT Template Electronic Application 4** - Shotgun shooting range danger templating using Google Earth.
- b. **Electronic ADAT library.** An electronic template library (in MS PowerPoint format) is available for you to download from the website so that you can copy and paste your selected ADAT for practical application. It is not necessary to download the complete file.
- c. **Shooting range danger area manual templating.** There are three videos that explain and demonstrate methods that can be used to determine a shooting range danger area by manual application of an ADAT. The videos can be paused, stopped, replayed or downloaded at your convenience.
 1. **Method 1 - ADAT Template Manual Application 1** - Firing point with a single line of fire.
 2. **Method 2 - ADAT Template Manual Application 2** - Firing line with a left of arc and right of arc.
 3. **Method 3 - ADAT Template Manual Application 3** - Firing box with a left of arc and right of arc.

- d. **Manual ADAT library-** A library of ADATs drawn to 1:50,000 and 1:25,000 scale are available for download from the website. The use and application of these ADATs is detailed in this section. To draw the scale diagram of the range danger area, first print the selected ADAT at 100% (to retain the correct scale), then photocopy it on to a transparency (film). The transparency can then be applied to a map of the same scale to determine the overall danger area.

Control of access to the range and the danger area

- 4.19 The shooting range operator must have control over access to the range and any associated range danger area at all times while the range(s) are in use. This control can be (but is not limited to) using physical barriers, signage (including warning flags), visual observation, or written/verbal agreements between affected parties etc. Range standing orders will list and explain any relevant control measures including a procedure where a breach occurs.

Shooting range signage

- 4.20 Range and danger area signage is required for all ranges except as set out in paragraph 4.24. Signs must be of durable construction to be weather resistant. The signs serve to alert the public to the presence and dangers of the shooting range and identify the range boundaries.

Shooting range entrance signage

- 4.21 There must be a sign at the main entrance to a shooting range and any secondary or alternative access point to the range. Secondary or alternative access point signage may not require as much information as the main entrance sign. Signage must contain the range or range complex name, contact details for the shooting club or shooting range operator (e.g., phone number, website or email address) and a warning that the person is entering a shooting range. If a flag is used at a range, there must be a sign by the flag explaining what a raised flag means and clearly stating any restrictions on access.

Shooting range danger area signs

4.22 Danger signs must be positioned around the perimeter of the overall range danger area to identify the boundary of the range. The purpose of these signs is to alert people to the presence of the range and range danger area boundaries. Signs must face outwards from the range danger area and be spaced at intervals so they are clearly visible to anyone who might approach the range. They must clearly warn people not to enter the range danger area, with wording such as **'DANGER, Firing Range, Keep Out'**. Range danger area signs must remain visible at all times and not be obscured by brush or vegetation. They should be of a colour and size that can be identified from approximately 100 metres away (this may not be possible in some environments). Perimeter signs should be checked periodically as part of the range maintenance plan to ensure they are in good order and all graphics and wording remain legible.

Alternatives to range danger area signs

- 4.23 If permanent danger area signs are not practicable for use on temporary non-pistol shooting ranges or non-pistol field shooting ranges, portable range danger area signage must be placed at all known vehicle or foot traffic access points into the range danger area (where practicable).
- 4.24 Where the use of portable range danger area signage is not practicable all reasonable measures must be taken to reduce the risk of unauthorised entry. Evidence of these control measures will be required for enrollment of temporary non-pistol shooting ranges or non-pistol field shooting ranges, such as an assurance from the landowner that access to the property is restricted to participants of the approved shooting activity. If signs are not to be used this must be included in range standing orders for the purpose of enrolment.

Figure 4.16
Example of red warning flags and containment system



Red Warning flags

4.25 A range complex or individual range must fly a large RED warning flag to indicate that the range is in use (see figure 4.16). The flag must be of a size and condition to stand out and be visible from the access point to the range. The flag must be flown from a flagpole at a height that can be easily seen. The flag should be a minimum dimension of 600 mm x 1200 mm. Indoor ranges are not required to display a range flag but must control entry into an active range area by signage, a locked access door (secured from the inside), warning lights (operation controlled from the inside), or a combination of these.

4.26 The flagpole must be in a prominent position and clearly visible to those approaching the range. If there is more than one entry point to the range and they are not visible from each other, then a flagpole is required at each entry point. The location and number of flagpoles depends on the design and layout of the range or multiple ranges at one site. Flagpoles must not be placed in a location that poses a hazard to anyone operating the flags, e.g., not on a backstop where due to the presence of an adjacent range, the flag operator would be exposed to fire from that range.

4.27 All individual ranges within a range complex must display a “range in use” warning flag, raised before shooting commences and lowered when shooting has concluded. This may extend to each bay where multiple shooting bays form part of the range. For night firing activities, red flags must be replaced with highly visible red flashing lights.

4.28 Signage explaining the meaning of a raised flag and clearly outlining the associated access restrictions must be installed at each range, or at any site using multiple range warning flags (see figure 4.17). The sign must be positioned where both the raised flag is visible and the signage can be easily seen by anyone approaching the range.

Alternate red warning flag requirements

- 4.29 Some shooting disciplines such as skeet and trapshooting may use a system of red and green signal flags or light systems. The correct operation of these flags and light systems must be clearly explained in their range standing orders and/or match rules.
- 4.30 Temporary non-pistol shooting ranges (e.g., sporting clay field shooting ranges) generally do not have the infrastructure to establish flagpoles or flag stations and are therefore not required to display warning flags, unless a temporary method is available for use. In lieu of a warning flag, a

portable warning sign (e.g., such as a sandwich board style or a sign fit for purpose) must be placed at the main access point to the location of the shooting activity. The range standing orders must also describe procedures for controlling other possible access points into the shooting range danger area.

Wind flags

- 4.31 The location of wind flags used on a range must not interfere with shooters or obscure the view of the active range area from the shooters or officers on duty.
- 4.32 Wind flags must be of a different shape and colour to all warning flags in use on the range. This is to avoid confusion over their meaning.

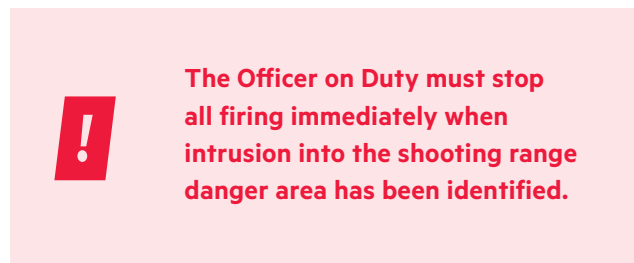

Figure 4.17 – Example of signage



Section 5



Backstop

Steel Targets

Range Floor

Shooting Facade

Side Wall

Safety Zone

Section 5

Range standing orders



Introduction

- 5.1 Range standing orders (RSOs) are a document that details the management procedures, firearm and ammunition restrictions, and conditions of use for the safe operation of the shooting range. They are required to ensure that all necessary precautions are taken to prevent accidents or incidents to range users and the public.
- 5.2 Shooting range operators are responsible for the production of range standing orders. They may be written for an individual range or multiple ranges located on the one site operated by the same shooting range operator. The shooting range operator is also responsible for ensuring that all range users comply with the range standing orders.

Risk assessment

- 5.3 A shooting range operator may have obligations under the Health and Safety at Work Act 2015 as person conducting a business or undertaking (PCBU). In such cases, it is recommended that a site-specific risk assessment is conducted. WorkSafe New Zealand provides guidance on the responsibilities of a PCBU.

Approval of RSOs

- 5.4 A copy of RSOs must be included with an application for:
 - a. certification of a pistol shooting range,
 - b. enrolment of a non-pistol shooting range,
 - c. renewal of certification for a pistol shooting range (with significant changes), and
 - d. notification of a temporary non-pistol shooting range.
- 5.5 RSOs for pistol shooting ranges must be approved by Police. Any additional changes to those RSOs that will or may affect the ballistic characteristics, operation or safety of the range can only be made with this prior approval.
- 5.6 RSOs for non-pistol shooting ranges can be approved by either the association the range is affiliated with or Police. Any additional changes to those RSOs that will or may affect the ballistic characteristics, operation or safety of the range can only be made with the prior

approval of the association the range is affiliated with or Police.

- 5.7 RSOs for temporary non-pistol shooting ranges can only be approved by either the association the range is affiliated with or Police.

5.8 Notification of changes to RSOs

A range operator of an enrolled non-pistol shooting range must ensure that notice is given to the Commissioner for any change to the RSOs, including those made with the prior approval of the association that the shooting range is affiliated with or Police. Notice must be given within 28 days of the change.

Notification to all range users

- 5.9 The shooting range operator must make the current version of the range standing orders accessible to all range users, whether in electronic or hard copy form, and provide notification of any approved amendments to the range standing orders. It is recommended that the shooting range operator displays the current version of the range standing orders on a noticeboard and/or website.
- 5.10 All persons trained as officers on duty are to routinely review range standing orders to refresh themselves on safe range operation which will include any approved amendments.

Range standing orders – Contents/guide/template

- 5.11 The contents of range standing orders are organised using a list of mandatory headings to ensure that all relevant aspects of range safety management are included. These headings provide a level of consistency for all range standing orders and allow for inclusion of specific shooting discipline requirements, e.g., shooting activities specific to shotgun, black powder, indoor etc. Where a heading may not be relevant to the specific shooting discipline, not applicable (N/A) should be entered (do not delete the heading as this will confirm that the heading has been considered). It is recommended that the headings follow the same order as listed in the guide.
- 5.12 A guide for the compilation of a set of range standing orders has been included at the end of this section.

The guide provides an explanation and examples of the type of information required under each heading. If a shooting discipline has additional information that needs to be included in their range standing orders, it is recommended that this information is included in section 33 (do not create a new heading).

- 5.13 A range standing orders MS Word Document template has been developed to assist shooting range operators to compile and produce shooting range standing orders to a consistent national standard. It is recommended that shooting range operators use the template, however, shooting disciplines may use their own template format as long as all mandatory headings are included. The template can be accessed from the Clubs and Ranges webpage of [Clubs and Ranges webpage of Te Tari Pūreke – Firearms Safety Authority](#) website.
- 5.14 Non-Pistol and Temporary Non-Pistol shooting ranges that are affiliated to an association may produce RSOs approved by their association to a standard set by their association. The Commissioner may request further information if it has been identified that these range standing orders may not meet the requirement for safe

operation of the shooting range(s). All other shooting range standing orders must comply with this manual.

Inability of a shooter to achieve and maintain the range design Coff

- 5.15 The inability of a shooter to achieve the range design Coff is a risk as projectiles may escape the range danger area. This could be the result of misdirected, random, or wild firing. Range standing orders must set out corrective actions if a shooter is unable to achieve the range design cone of fire. If unable to correct the error, the shooter must cease shooting. For shotgun shooting activities, the Officer on Duty is to apply the same process where a shooter is not able to achieve or maintain their shot-spread within the designated arcs of fire.

Range danger area description

- 5.16 A description of the range danger area can be included in section 10 of the RSOs as part of the individual range description. Reference can be made to the relevant annex for the scale diagram and specific details of the range danger area (where applicable). A no danger area (NDA)

Figure 5.1 – Example of the scale diagram of the range danger area and supporting information required for inclusion in RSOs (where applicable)

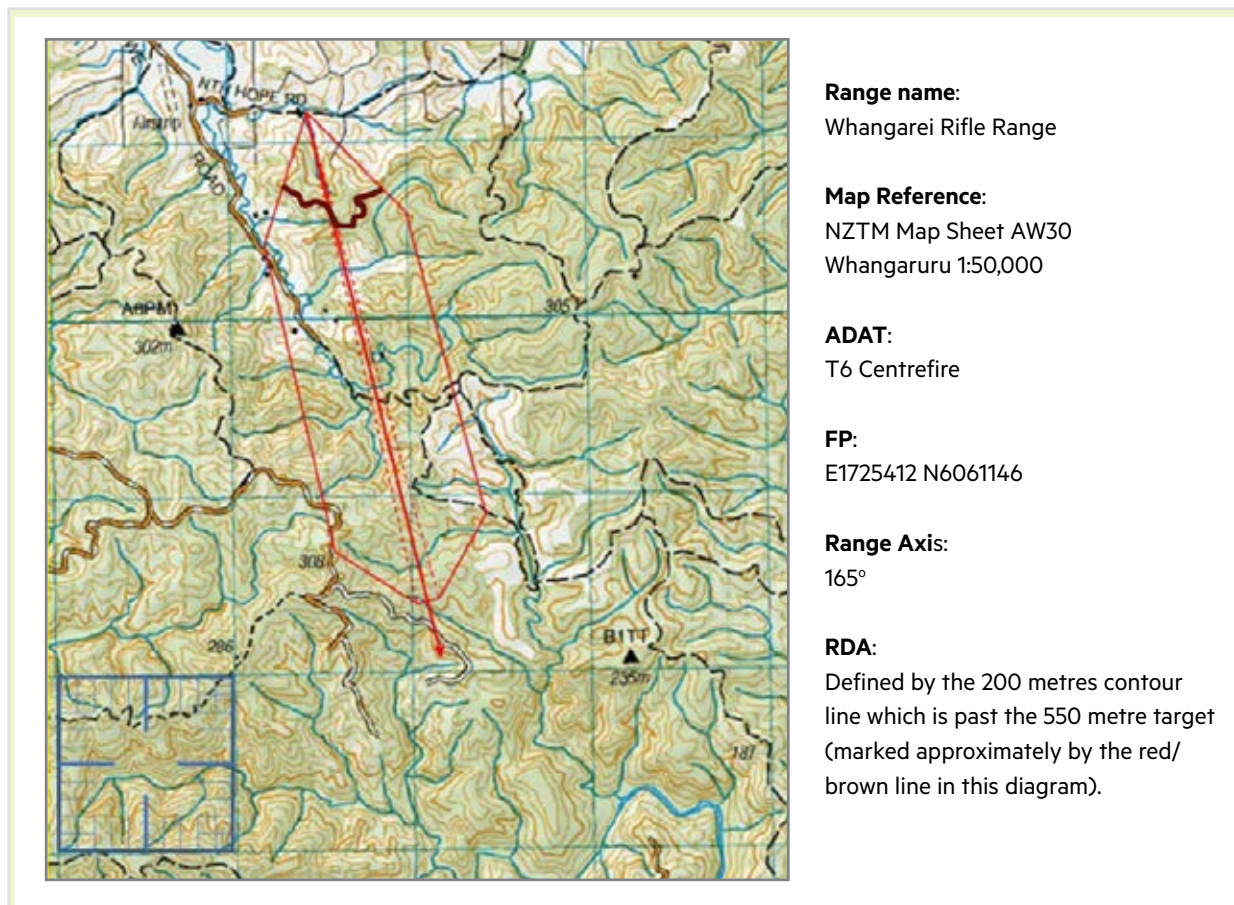

range does not require a reference to a scale diagram of the range danger area in the annex.

5.17 When a range danger area scale diagram has been produced, it must have the following explanatory notes annotated within the diagram or inserted as part of the marginal information included with the diagram (see figure 5.1):

- a. Range name/number.
- b. ADAT applied (e.g., T6).
- c. Map sheet reference number.
- d. Grid reference to the furthest firing point/line/box (in NZTM) from where the template has been applied (and the closest firing point from where the template has been applied).
- e. Range axis (direction of fire) in degrees as a grid bearing.
- f. Left and right of arcs in degrees as a grid bearing.
- g. Description of the cut off point for a reduced danger area range.
- h. A description or outline of the approved land boundary or any other relevant information.

Provision for restricted weapons, prohibited firearms and magazines

5.18 Restricted weapons/prohibited firearms and magazines may be permitted for use on a certified or enrolled shooting range where they have been approved by the shooting range operator and included in section 10 of the RSOs. The firearms licence holder must have the appropriate endorsements for the firearm or magazine to be used.

Individual range summary sheet

5.19 It is recommended that each shooting range has a range summary sheet displayed listing the relevant restrictions and conditions of use specific to that range, e.g., an extract from section 10 of the RSOs listing the approved firearms and calibres. These sheets provide a brief summary to all range users of the operating restrictions and conditions of use for the range but do not remove the requirement to have the current version of the range standing orders available to all range users. An example of a summary sheet is at figure 5.2.

Figure 5.2 – Example of RSOs individual range summary sheet

Range 1

Restrictions and conditions of use:

- No aerial targets.
- Down-range shooting only between 50 metre firing line and 25 metre target fixtures.
- No targets placed at left side berm between 50 metre firing point and 25 metre target fixtures.
- Beyond 25 metre target line the range can be shot left and right into side berms out to a distance of 10 metres.
- Steel targets shall only be used beyond the 25 metre target fixtures.
- No steel setup within 7 metres (5 metres for CAS) of firing position (see Range Standing Orders 17).
- Bullet catchers (filled blue barrels) are required for all targets where bullet impact may strike within yellow 'no impact' areas or impact the ground from any firing position.
- Bullet catchers must cover cone-of-fire from every possible firing position (See Range Standing Orders 16.1 for details)

Bullet Catcher Example:



Range Flags required:
Main Gate Flag +
TPC Flag 1



Allowed Firearms and Targets for this range:



Pistols and Pistol Carabines up to and including .50 cal.



Pistols calibre rifles up to and including .45 cal.



Rifles up to and including 8mm.



Shotguns up to and including 12 gauge



Black Powder rifle up to and including .75 cal.



Black Powder pistol



Any paper targets



Popper targets



Steel targets

Table 5.1 – **Guide for the compilation and production of RSOs**

If a heading is not relevant to your range operation, do not delete the heading, rather insert N/A for not applicable. This is to ensure a consistent standard is maintained for all Police approved RSOs.

The Shooting Range Operator (SRO) is responsible for producing the Range Standing Orders (RSOs)	
1	Shooting Range/Multi-Range site name
2	Shooting Range name or number (if an individual shooting range(s) if applicable)
3	RSOs date (date RSOs were authorised)
4	Introduction (Information to be included) <ol style="list-style-type: none"> 1. Information about the range 2. The legal title of the land on which the range is located, and any associated land affected by the range danger area (if applicable) 3. The name of the landowner(s) or controlling authority approving the use of their land as a shooting range 4. Hours of operation
5	Responsibility (Information to be included) <ol style="list-style-type: none"> 1. Name of the (SRO), (who is responsible for the overall safe operation of the range), and 2. The person/entity/committee in charge of the day-to-day administration, management and maintenance of the range
6	Compliance with Range Standing Orders (RSOs) (Information to be included) <ol style="list-style-type: none"> 1. Statement directing that all range users must comply with RSOs 2. Describe the consequence of non-compliance with RSOs
7	Range location (Information to be included) <ol style="list-style-type: none"> 1. Physical street address of the range 2. NZTM map sheet number and grid reference
8	Approved range users and priority of use (Information to be included) <p>List approved range users/organisations and their order of priority for range use and bookings (if applicable)</p>
9	Warning flags, warning lights and danger signs (Information to be included) <ol style="list-style-type: none"> 1. Locations of warning flags, and warning lights (if applicable), danger signs and their use 2. Flag locations may be included in Annex A – Range location and layout
10	Description of individual ranges, restrictions, and conditions of use (in numerical order - information to be included)
10.1	<p>Range 1 - Description:</p> <ol style="list-style-type: none"> 1. <i>Maximum firing distance, indoor/outdoor, type of shooting discipline and type of range danger area e.g., 50m Outdoor Pistol RDA range</i> <i>Range danger area – A description of the range danger area (if applicable)</i> 2. <i>Where a range is designated a FDA or RDA range, a scale diagram of the range danger area is to be included as an annex (a scale diagram is not required for a NDA range) For a RDA range, the designated cut-off point for the reduction of the danger area is to be clearly defined</i> <p>Range 1 – Restrictions: List the restrictions of the firearm calibres and ammunition approved for use on the range. This can be expressed as the maximum calibre, cartridge, muzzle velocity or muzzle energy, or a combination of these factors where necessary, e.g.,</p> <ol style="list-style-type: none"> 1. <i>Pistols up to and including 0.50in calibre with a muzzle velocity no greater than 1600 fps (488 m/s).</i> 2. <i>Rifles up to and including 8mm.</i> 3. <i>Shotguns up to and including 12 gauge with a muzzle velocity no greater than 1350 fps</i> 4. <i>Shot size up to and including 2.4mm with a shot weight no greater than 28 grams</i> <p>Explanatory note: <i>Some modern firearms may exceed the calibre restriction but not the muzzle energy restriction. In such cases, as long as the firearm is within either the calibre or muzzle energy restriction for the range it may be approved for use</i></p>

	<p>Range 1 – Conditions of use: List the conditions of use specific to this range e.g.,</p> <ol style="list-style-type: none"> 1. Range 1 must be closed for use when Range 2 is in operation 2. Down range shooting only 3. All shooting must be from the prone supported position only 4. All shooting must be from the shooting bench at the 100m firing point only
	<p>Explanatory note: For multiple ranges, copy and paste the complete Range 1 format and insert it after Range 1, for the additional number of ranges required and renumber accordingly, e.g.,</p> <p>10.2 Range 2:</p> <ol style="list-style-type: none"> a. Description b. Restrictions c. Conditions of use <p>10.3 Range 3:</p> <ol style="list-style-type: none"> a. Description b. Restrictions c. Conditions of use
11	<p>Range safety roles (<i>Information to be included</i>)</p> <p>Describe the requirements for Duty Officers/Officers on Duty/Range Officers and any other persons with a designated role for managing range safety:</p> <ol style="list-style-type: none"> 1. RSOs must state as a minimum that an Officer on Duty has a firearms licence and is appropriately trained in shooting range safety management and is to be on duty for each individual range at all times when in use 2. RSOs may state the requirement for any additional safety roles for the safe conduct of a shooting activity
12	<p>Range safety rules (<i>Information to be included</i>)</p> <ol style="list-style-type: none"> 1. Generic safety rules for the use of the range 2. Any specific requirements before, during and after shooting 3. Approved shooting activities 4. Developed shooting activities must be reviewed for approval by the shooting range operator before inclusion in RSOs
13	<p>Ammunition use (<i>Information to be included</i>)</p> <p>Describe any relevant criteria regarding ammunition that is not required in Section 10 under restrictions. Describe the procedure for the introduction of new ammunition, e.g.,</p> <p><i>If a new type of ammunition is proposed for use on the range, it must be approved by the SRO. Before inclusion in the RSOs, the requirements of section 34 of these orders are to be adhered to.</i></p>
14	<p>Targets (<i>Information to be included</i>)</p> <ol style="list-style-type: none"> 1. Describe approved soft and hard target types to be used 2. Describe the correct placement of targets 3. State the approved target centre height(s) for all targets and target locations 4. Describe the procedure for approval and use of new targets or target systems 5. Describe the use of a shotgun pattern board (if applicable)
15	<p>Steel Targets (<i>Information to be included</i>)</p> <p>Describe the procedure for the use of approved steel targets Describe the grade of steel approved for steel targets Describe the procedure for inspecting and maintaining steel targets to a safe and serviceable standard</p>
16	<p>Moving Targets (<i>Information to be included</i>)</p> <p>Describe the procedure for the operation of moving targets (if applicable)</p>
17	<p>Minimum safe engagement distances (<i>Information to be included</i>)</p> <p>List the minimum safe engagement distances by shooting activity, firearm calibre, ammunition type, and target type</p>

18	Hearing and eye protection <i>(Information to be included)</i>
	Describe the requirements for the use of hearing and eye protection
19	Medical and emergency <i>(Information to be included)</i>
	<ol style="list-style-type: none"> 1. Describe the location of the first aid/medical kit 2. Describe a suitable method (cell phone/landline/radio) to contact emergency services 3. Describe the location or address of the closest medical facility if evacuation of a casualty is required
20	Accident/incident procedure <i>(Information to be included)</i>
	<ol style="list-style-type: none"> 1. Describe the procedure in the event of an accident/incident on the range during live firing not involving a firearm which results in a non-urgent injury or where an injury could have occurred (e.g., a near miss) 2. Describe the procedure in the event of an accident /incident on the range during live firing involving a firearm or ammunition which results in serious injury or death (including a near miss)
21	Fire precautions and procedures <i>(Information to be included)</i>
	<ol style="list-style-type: none"> 1. Describe the location of any onsite fire alarms and equipment (if applicable) 2. Describe the evacuation procedure in the event of a fire 3. Describe any relevant seasonal fire restrictions that must be complied with (if applicable)
22	Range clearance <i>(Information to be included)</i>
	Describe the procedure for clearance (and clean up) of the range at the completion of all shooting for the day (or night)
23	Range design Cone(s) of Fire (CofF)/Arc of Fire (AofF) <i>(Information to be included where applicable)</i>
	List all approved range design cone(s) of fire for all ranges (or arcs of fire for shotgun ranges)
24	Unauthorised access or use of the range <i>(Information to be included)</i>
	Describe the procedure for managing unauthorised access or use of the range
	Range intrusion procedure Describe the procedure taken when an intrusion is about to occur or has occurred
25	Inability of the shooter to achieve the range design CofF <i>(Information to be included)</i>
	Describe the procedure for validating and monitoring the ability of a shooter to achieve and maintain the approved range design CofF, and the corrective actions if a shooter is unable to do so
26	Un-licenced or inexperienced shooters <i>(Information to be included)</i>
	Describe the procedure for managing an un-licenced or inexperienced shooter on the range. The requirements of the Arms Act 1983 must be adhered to as a minimum for un-licenced shooters
27	Test firing
	Describe the procedure for managing test firing of firearms and/or ammunition on the range. Test firing does not include sighting-in or zeroing. The SRO must approve any type of test firing
28	Air danger height (ADH) <i>(Information to be included)</i>
	<ol style="list-style-type: none"> 1. List the approved ADH for the range (if applicable) 2. Describe the procedure for aircraft intrusion over the range danger area 3. Describe any procedure required by agreement with the local aerodrome(s) or CAA for use of the range (if applicable)
29	Range maintenance plan <i>(Information to be included)</i>
	<ol style="list-style-type: none"> 1. Provide a range management plan (or reference to) which schedules regular maintenance checks of the range(s) e.g., detailing the requirements for checking and refurbishment of the bullet catcher fill material (if applicable). The standard of the range maintenance will be assessed against the range maintenance plan
30	Children (minors) <i>(Information to be included)</i>
	Describe the rules for supervision of children (minors) on the range

31	Health and hygiene <i>(Information to be included)</i>
	Describe the rules for relevant health and hygiene procedures, e.g., washing hands before handling food after shooting
32	Domestic animals <i>(Information to be included)</i>
	Describe the rules for allowing domestic animals on the range
33	Additional headings <i>(Information to be included)</i>
	List any other information deemed necessary for inclusion in the RSOs for the safe management and operation of the range, e.g., <ol style="list-style-type: none"> 1. Rules for the use of the carpark 2. Security procedures for entry and exit to the range complex or a specific range(s) 3. Additional range safety rules for specific shooting activities 4. Additional conditions for use of specific firearms, e.g., black powder cannons and mortars
34	Amendment to RSOs <i>(Information to be included)</i>
	Describe the procedure for approval of amendments to RSOs NB: Police must be notified of any proposed amendment to RSOs for review and prior approval (for Pistol shooting ranges and non-pistol shooting ranges that are not affiliated to an association only)
35	Amendment to RSOs <i>(Information to be included)</i>
	State who authorised the RSOs, e.g., <ol style="list-style-type: none"> 1. These RSOs have been authorised by the XXXX Club Inc. Committee, or 2. These RSOs have been authorised by the XXXX (name of the SRO) NB: There is no need for a signature or date in this section
36	Distribution list <i>(Information to be included)</i>
	List all approved range users and associated organisations who will be sent a copy of the RSOs
37	Annexes <i>(specific information required to supplement content in the main body - information to be included)</i>
	List the Annexes in alphabetical order. Each annex should be presented on an individual page for clarity, e.g., <p>A - Range location and layout</p> <ol style="list-style-type: none"> 1. A google earth image or Topo50 Map image identifying the geographical location of the range/range complex 2. A google earth or Topo50 map or diagram of the plan view of the range/range complex (may include flag locations) <p>B - Range danger area</p> <ol style="list-style-type: none"> 1. A scale diagram illustrating the FDA/RDA including the boundary of the land approved for use as a shooting range. This is not required for a NDA range 2. This diagram must also list the grid reference(s) to the firing point/firing line/firing box, range axis, left and right of arcs (if applicable), the ammunition danger area template used 3. For an RDA range, the designated cut-off point for the reduction of the danger area is to be clearly defined <p>C - Additional shooting organisations</p> <p>Where more than one shooting organisation uses the range, specific rules for their discipline can be added as an annex. They must not contradict these RSOs. The annex must be reviewed and approved by the SRO for inclusion in these RSOs, e.g., A Police Annex is required if NZ Police use the range</p> <p>D - Any other relevant information</p> <p>Information, tables and images that are more suited to be included as an Annex to reduce clutter in the main body of the RSOs, e.g. A table of equivalency for approved ammunition</p>

Section

6

Bullet Catcher

Target Holders

Side Berm

Target Line

Range Floor

**RANGE
CLOSED**

Section 6

Shooting range closure



Shooting range closure

- 6.1 A shooting range may be closed for a temporary period or closed permanently. Where a shooting range has been closed temporarily or permanently, the shooting range operator must take steps to clearly indicate that the shooting range is closed, e.g., range closed signage.

Temporary closure

- 6.2 A shooting range operator may close a shooting range temporarily for the purpose of administration, scheduled maintenance, unplanned repair work or due to an adverse weather event such as flooding. The shooting range operator is not required to notify Police in such circumstances and may reopen the range when appropriate.
- 6.3 A shooting range operator must immediately cease operations on a range when they identify continued operations will endanger the safety of the public or range users. The shooting range operator must temporarily close the range until the circumstances are investigated and any remedial action is completed to ensure the safe operation of the range. The shooting range operator may reopen the range when it is confirmed safe to do so. If it can be confirmed that the public has been exposed to risk, e.g., projectile overshoot, then the shooting range operator must report the circumstances to Police.
- 6.4 Any individual using a range who considers the range unsafe must cease using it and report the circumstances as soon as practicable to the shooting range operator or member of the club executive committee. On receipt of this notification, the shooting range operator or club committee must close the range temporarily while they investigate the circumstances of the report. The shooting range operator or club committee can reopen the range when it is safe to do so.
- 6.5 Where a member of the public reports a shooting range to be unsafe, a member of Police constabulary may direct that the range(s) cease operation temporarily until the circumstances of the report can be investigated. Clubs and Ranges may be required to assist with the investigation. Police may direct that the range can reopen when it is confirmed safe to do so, or issue an improvement notice to remedy any condition(s) of certification or enrolment that has not been met.

- 6.6 A member of Police conducting a regulatory shooting range inspection may issue an improvement notice where it is identified that a shooting range does not comply with the conditions of certification or enrolment. The conditions stated in the improvement notice may require the shooting range operator to temporarily cease operation until remedial action has been taken to ensure the safe operation of the range. If the shooting range operator does not cease operations Police may suspend certification or enrolment.
- 6.7 A member of Police may temporarily suspend the operations of a shooting range if the member is satisfied that the shooting range has failed to comply with an improvement notice.

Permanent closure

- 6.8 If a shooting range operator fails to comply with an improvement notice, and the Police review during the period of the suspension notice concludes that the range can no longer meet the conditions of certification, Police will cancel range certification or enrolment.
- 6.9 Where the owner (or controlling authority) of the land, on which the range and danger area is situated, withdraws authority for the use of the land as a shooting range (e.g., if the lease or licence is terminated), the shooting range operator must inform Police and cease using the range when the authority has ended. If the shooting range operator is unable to obtain a new authority to use the land, then the range must cease operations. Police will review the situation and confirm that the range can no longer be operated under the conditions of certification or enrolment. Once confirmed, Police will cancel range certification or enrolment.
- 6.10 A shooting range operator may voluntarily surrender the certification or enrolment of a shooting range by notifying Police. Police will review the notification and confirm the details for permanent closure of the shooting range with the shooting range operator. On confirmation, Police will cancel range certification or enrolment.

Decommissioning

- 6.11 When a shooting range is to be decommissioned and closed permanently, Police will cancel the range certification or enrolment. All range signage and range structures are to be removed to ensure there is no continued use of the shooting range by any person. Other remediation may be required by the landowner or occupier.



Section

7



Section 7

Zeroing (sighting-in/sight adjustment) conducted on private/public land



Zeroing (sighting-in/sight adjustment)

- 7.1 Zeroing (sighting-in) that is done by an individual or a small group of individuals (but not a shooting club) on a one-off or occasional basis (e.g., before a hunting trip or duck-shooting season), should, where possible, be conducted on a certified or enrolled shooting range. Where a certified or enrolled shooting range is not available or practical, zeroing (sighting-in) can be carried out on private or public land with the permission of the landowner or controlling authority. The following must be considered:
- a. Identify an area of land that you own, control or have permission to shoot on. It should be away from populated areas and selected so as not to endanger, frighten, or annoy members of the public, and where there are no buildings or human activity. Buildings in the danger area that are not at risk of direct impact must be vacant of human activity when shooting (e.g., an implement shed).
 - b. Select a safe backstop within the area (this is critical). A large bank or hill immediately behind the target is recommended. Trees or vegetation without solid ground behind them do not constitute a reliable backstop. The steeper the slope of the natural hill feature the better as it reduces the potential for ricochet.
 - c. A rifle bullet can travel several kilometres even after a ricochet, therefore the direction of fire should be oriented so that the fall of shot area extending beyond the target does not contain roads, dwellings, buildings or areas of human activity. Ideally the bank or hill (backstop) immediately behind the target should be high enough to contain direct impact and ricochets.
 - d. Avoid hard or stony surfaces likely to cause a ricochet or backsplash. If a ricochet is heard when shooting, stop shooting and select a more suitable location.
 - e. Select an area where you have control and full visibility of anyone entering the danger area. Avoid selecting backstop areas where members of the public or people such as farm staff might enter the danger area without your knowledge. Check for roads, tracks, accessways or river flats where you don't have full visibility of the danger area.
 - f. Select targets that will not create a ricochet or backsplash e.g., paper, soft timber or suitable steel targets (positioned correctly). Targets should be placed centrally at the base of the backstop (bank or hill) to ensure all bullets will be captured by the backstop.
 - g. Avoid areas with livestock where possible. Where livestock are present, do not shoot unless they are well clear of your target area.
 - h. Ensure that everyone handles firearms safely and follow the seven rules of firearms safety.
 - i. Areas set up for and routinely used by the public or a shooting club for sighting-in must be established as an enrolled shooting range.
- 7.2 For further guidance refer to section 6 (Preparing your firearm for use and zeroing) of the [Firearms Safety Code](#).

Section

8

Backstop

Range Floor

Shooting Stand

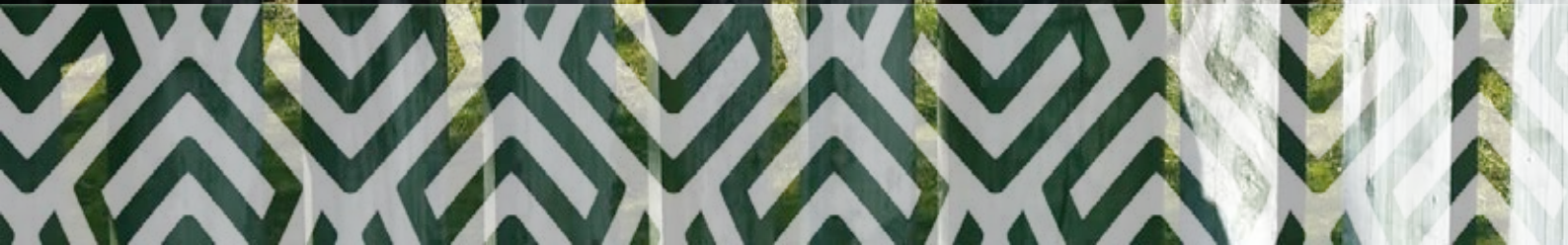



References

- 8.1 When developing this manual the following international publications were used for reference:
 - a. UK Ministry of Defence: Defence Safety Authority, Defence Ordinance Munitions & Explosives Safety Regulator (2020) DSA 03.OME, part 3, volume 2 –Defence code of practice and guidance notes for ranges.
 - b. Royal Canadian Mounted Police (2007) Range design and construction guidelines. The Canadian Firearms Centre, Canada, 2007.
- 8.2 New Zealand Police have drawn on the above referenced publications for shooting-range design and construction, adapting these standards to better suit the civilian shooting community in New Zealand. Where original guidance was developed for military weapon systems and operational training, the New Zealand Police Shooting Range Manual reflects the requirements and considerations of civilian shooting across all disciplines and range environments.
- 8.3 Police also used shooting range publications developed by national and individual shooting organisations listed below, as a point of reference for specific shooting disciplines:
 - a. New Zealand Clay Target Association.
 - b. New Zealand Deerstalkers Association.
 - c. Pistol New Zealand.
 - d. National Rifle Association of New Zealand.
 - e. Target Shooting New Zealand.
 - f. New Zealand Black Powder Shooters Federation Inc.
 - g. Field Shooting New Zealand.
 - h. The Amateur Trapshooting Association.
 - i. The New Zealand Air Rifle Field Shooting Target Association.
- 8.4 The Police Shooting Range Manual takes precedence over all other source documents relating to pistol shooting ranges, as well as non-pistol shooting ranges that are not affiliated with an association. Police may approve the use of alternative range design criteria where they are satisfied that any certification or enrolment that differs from this manual will not compromise the safe operation of the shooting range. The shooting range operator is responsible for ensuring that all shooting activities comply with the conditions of the range’s certification or enrolment. Any request for a deviation from the manual

shall be submitted to Police, together with all necessary supporting documentation, for review and decision.

Acknowledgements

- 8.5 Police recognises Pistol New Zealand and the New Zealand Defence Force for their contribution to the production of this manual. Relevant parts of this manual have been reviewed by the Weapons and Range Safety Branch of the New Zealand Army, and by Mr Frank Compton (Maj Retd) MBE, Range Safety Advisor and international subject matter expert.

Range Certification Engagement Group

- 8.6 During the development of this manual the range certification engagement group was established to ensure the input of key stakeholders within the firearms shooting community of New Zealand. Members representing key stakeholder groups contributed subject matter expertise, peer review and feedback during and after the development of this manual. Key stakeholder groups are listed in table 8.1 below.

Table 8.1 – Range certification engagement group

ORGANISATION
Council of Licensed Firearms Owners
Field Shooting Advisory Group
Firearms Safety Council of Aotearoa New Zealand
Gillice Practical Rifle Events
Gunsafe Firearms Safety and Education
New Zealand Clay Target Association (also representing the New Zealand Shooting Federation)
New Zealand Deerstalkers Association
New Zealand Game Animal Council, Federated Farmers of New Zealand, Professional Hunting Guides Association
New Zealand Army Weapons and Range Safety Branch
New Zealand Police - Clubs and Ranges
National Rifle Association of New Zealand
Pistol New Zealand (also representing the New Zealand Service Rifle Association)
Target Shooting New Zealand



Te Tari Pūreke
Firearms Safety Authority

New Zealand Police

Shooting Range Manual



Te Tari Pūreke – Firearms Safety Authority